



Stainless steel pipe systems

... for a smooth material flow

Welcome to



... your system supplier for pneumatic conveyor system builders.



Please also visit our website as well, and take a look at our new company video ...

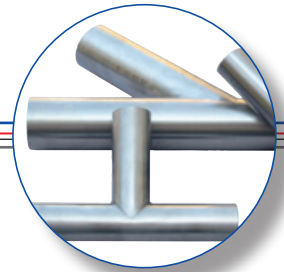
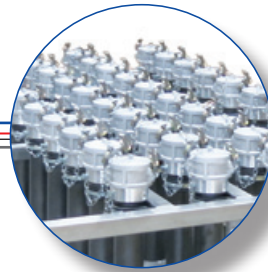
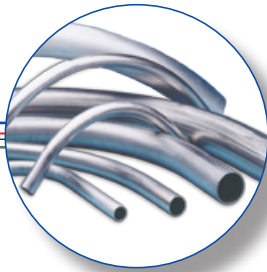

Thanks to our large warehouse stocks we are in a position to supply **stainless steel pipe bends**, pipe couplings, branch pipes, reducers **and pipes** in all common sizes and diameters at short notice.

Even for custom-made parts, our fast delivery response and our flexibility guarantee your success. In this way you can optimise your delivery times and lighten the load on your purchasing department.



We are specialists for

- Stainless steel pipe bends
- Aluminium pipe bends
- Pipe couplings
- Stainless steel pipes
- Glass pipe/Glass pipe bends
- HVA NIRO® pipe bends
- Branch pipes
- Pipe connectors
- Reducers
- Coupling stations
- Suction lances
- PU-Hoses



Highly wear-resistant versions

HVA NIRO® Stainless steel pipe bends



page 40

Glass pipe bends



page 50

Double-skin pipe bends (DWR)



page 52

HVA NIRO® Branch pipes

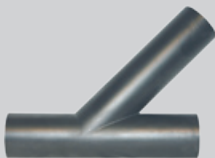

page 84

HVA NIRO® Stainless steel Coupling stations



page 97

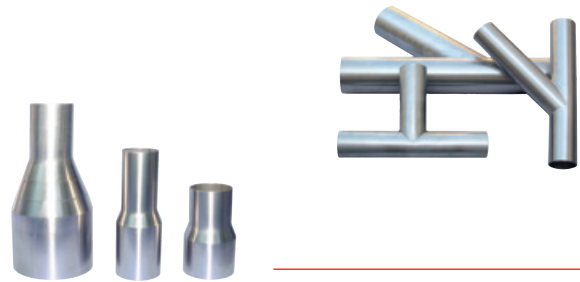
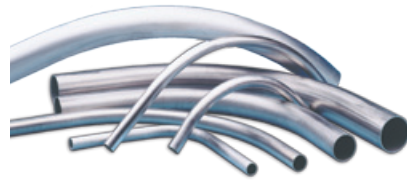

Delivery program

Pipe bends		Stainless steel pipe bends	6
		Aluminium pipe bends	34
		HVA NIRO® Stainless steel pipe bends ⚠ highly wear-resistant	40
		Glass pipe bends ⚠ highly wear-resistant	50
		Double-skin pipe bends (DWR) ⚠ highly wear-resistant	52
		Pneumatic tube pipe bends	54
Pipes		Stainless steel pipes	56
		Aluminium pipes	58
		Glass / Sightglass ⚠ highly wear-resistant	59
Pipe couplings	DVK-HD®	DVK-HD® high pressure	62
		DVK-HD® anodized version	66
		Pipe coupling stainless steel	67
		DVK-HD® quick closure	68
		Traction relief	69
		DVK-HD® with traction relief	70
	DVK-6	DVK-6	72
		DVK-6 quick closure	76
		DVK-6 express closure NEW	77
		DVK-6 Fix	78
		DVK-6 with stainless steel inner ring	78
		DVK-6 for different diameters	79
		Plugs (plastic)	79
Branch pipes		Stainless steel	80
30° 45° 90°		HVA NIRO® ⚠ highly wear-resistant	84
		Glass ⚠ highly wear-resistant	84
Reducers		Stainless steel	85
		Glass ⚠ highly wear-resistant	90
		HVA NIRO® Stainless steel ⚠ highly wear-resistant	90
Suction lances		Aluminium suction lances with spacer	92
		Stainless steel suction lances with spacer and chamfered	93
		Stainless steel suction lances with spacer	94
		Stainless steel suction lances with chamfered	95
Coupling stations		Stainless steel	96
		HVA NIRO® Stainless steel ⚠ highly wear-resistant	97
		Glass ⚠ highly wear-resistant	97
		Special versions	100
Special parts		Special branch pipes	102
		Special pipe bends	
		Studs	
		Angle pieces	
PU-Hoses		Master-PUR H Trivolution	104
		Master-PUR HX Trivolution	106
		NORPLAST® PVC-CU 384 AS	107
Accessories		Gaskets	108
		Hose clamps	109
		Hose clamps with screw thread	109
		Camlock	110
		Storz	114
		Pinch valve switch	116
		Empty suction switch	117

Stainless steel pipe bends

for pneumatic conveying systems

HS Umformtechnik is your reliable partner for the production of thin-walled pipe bends with large bending radii, especially those used in pneumatic conveyors. Our products are coldbent without wrinkles on state-of-the-art CNC mandrel bending machines.

On request we can produce extension pipe bends according to your specific requirements. Besides our standard range of stock products in stainless steel, we also process aluminium.

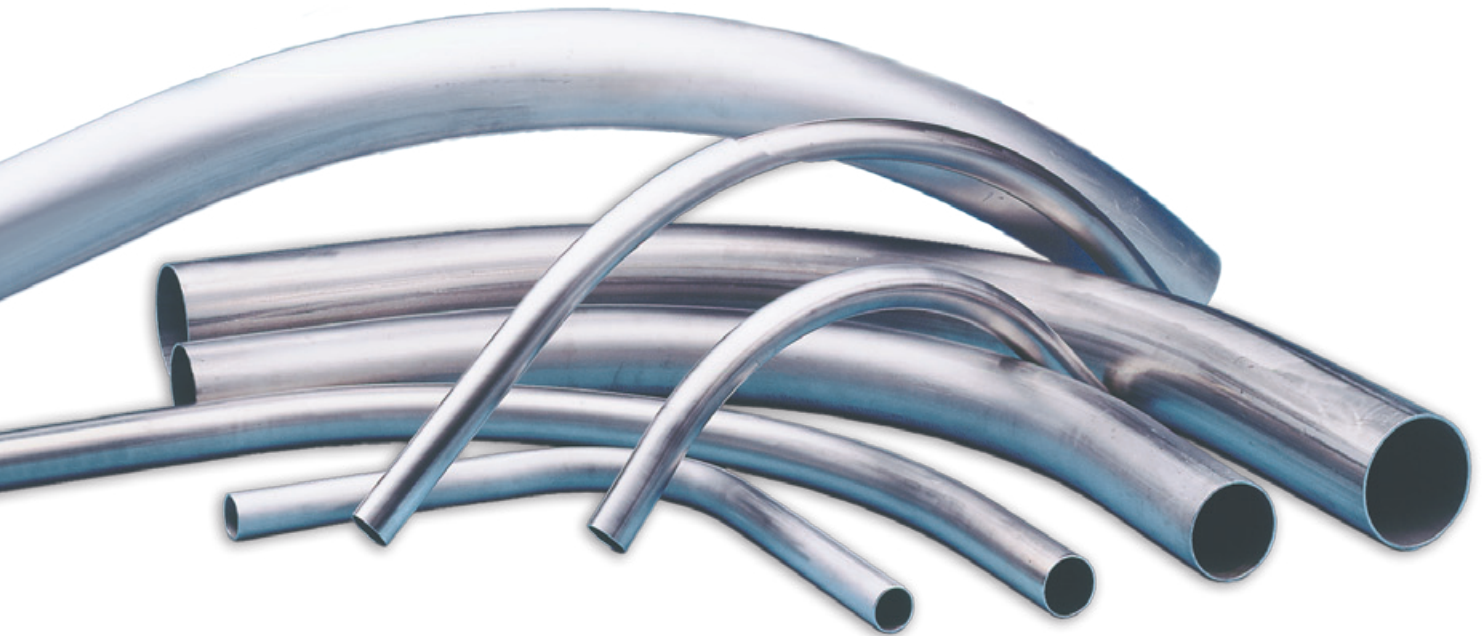

- Leg extension each side
- Pipe bends in material no. AISI 304 / AISI 304 L
- Welded seam smoothed or shaved DIN 11 850 / DIN EN 10 357
- Absolutely wrinkle-free
- No start-up bulges
- No scratching or scoring
- Extremely low ovality
- Visually aesthetic surface
- Outer diameter from 38.0 - 206.0 mm
- Wall thickness of 1.5 mm/ 2.0 mm

... thicker-walled also available at short notice!

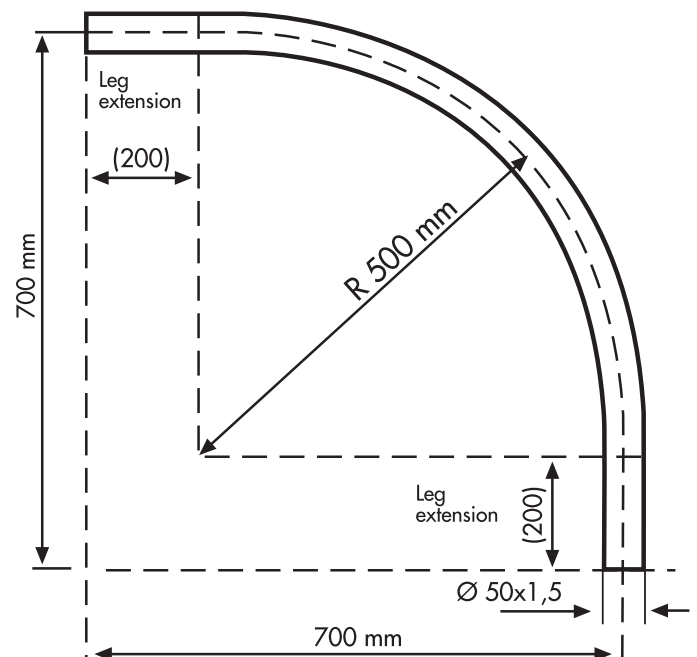

Tool- / Stock list

for our CNC mandrel machines

Stainless steel pipe bends – from stock AISI 304

AISI 316 L / AISI 316 Ti or other materials at request

Diameter in mm	Radius in mm											
	75	100	115	150	180	250	300	500	800	1000	1200	1500
38,0 x 1,5	70					●	●	●	●	●		
40,0 x 1,5	●	●				●		●	●	●		
45,0 x 1,5	●	●					●	●	●			
48,3 x 2,0		96		●			●	●				
50,0 x 1,5	●	●		●	●	●	●	●	●	●		
50,0 x 2,0	●	●		●		●	●	●	●	●		
50,8 x 1,5	●					●		●	●	●		
54,0 x 2,0	●			●		●		●	●	●		
60,3 x 1,5		●	●		●	●	●	●	●	●		
60,3 x 2,0		●	●		●	●	●	●	●	●		
63,5 x 2,0					160	●		●	●	●		
65,0 x 1,5			●			●	●	●	●	●		
65,0 x 2,0			●			●	●	●	●	●		
70,0 x 2,0		95		●		●		400	●	●		
76,1 x 2,0					●	●	●	400	●	●		
80,0 x 2,0				●		●		●	●	●	●	●
80,0 x 2,5				●		●		●	●	●	●	●
84,0 x 2,0				●		●		●	●	●		
85,0 x 2,0				●		●		●	●	●		
88,9 x 2,0				●		●		385	●	●	●	
100,0 x 1,5				●		●		●	●	●	●	●
101,6 x 2,0				●				●	●	●	●	
104,0 x 2,0				●				●	●	●	●	●
108,0 x 2,0				●				●	●	●	●	
110,0 x 2,0								●	●	●	●	
114,3 x 2,0				●				●	●	●	●	
125,0 x 2,0								●	●	●		
128,0 x 1,5								●	●			
129,0 x 2,0								●	●	●	●	●
133,0 x 3,0								●	●	●		●
139,7 x 2,0								●	●	●	●	●
154,0 x 2,0								●	●	●	●	●
156,0 x 3,0								●	●	●		●
159,0 x 2,0								●	●	●	●	●
168,3 x 2,0								●	●	●	●	●
204,0 x 2,0									●	●	●	●
206,0 x 3,0										●	●	●

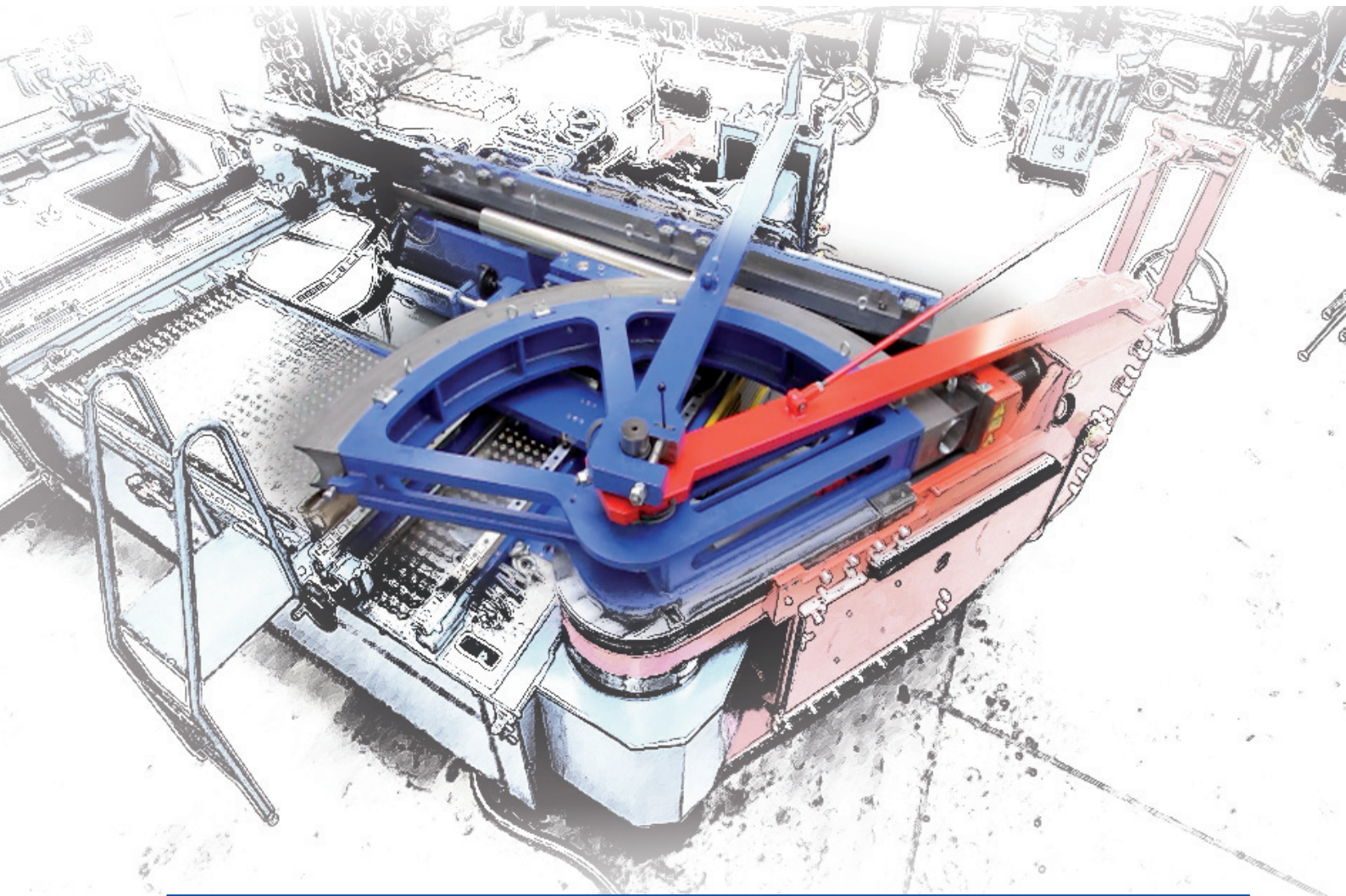

Stainless steel pipe bends \varnothing 38.0 x 1.5 mm

Outer pipe diameter	Wall thickness	Radius	Angle	Leg extension	Weight	Article number
38.0 mm	1.5 mm	70 mm	90°	100 mm	0.42 kg	103810001
38.0 mm	1.5 mm	70 mm	45°	100 mm	0.35 kg	103810002
38.0 mm	1.5 mm	250 mm	90°	100 mm	0.81 kg	103810201
38.0 mm	1.5 mm	250 mm	45°	100 mm	0.54 kg	103810202
○ 38.0 mm	1.5 mm	300 mm	90°	100 mm	0.92 kg	103810310
○ 38.0 mm	1.5 mm	300 mm	45°	100 mm	0.60 kg	103810311
38.0 mm	1.5 mm	500 mm	90°	100 mm	1.35 kg	103810501
38.0 mm	1.5 mm	500 mm	45°	100 mm	0.81 kg	103810502
○ 38.0 mm	1.5 mm	500 mm	90°	200 mm	1.62 kg	103810505
○ 38.0 mm	1.5 mm	500 mm	45°	200 mm	1.09 kg	103810503
38.0 mm	1.5 mm	800 mm	90°	200 mm	2.27 kg	103810802
38.0 mm	1.5 mm	800 mm	45°	200 mm	1.41 kg	103810803
38.0 mm	1.5 mm	1000 mm	90°	200 mm	2.70 kg	103810004
38.0 mm	1.5 mm	1000 mm	45°	200 mm	1.62 kg	103810014

also in other angles available...

○ = no stock article | available at short notice

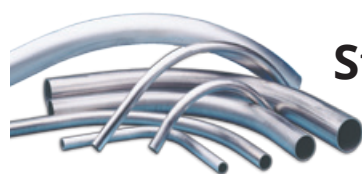

Stainless steel pipe bends

Material no. AISI 304 / 304 L

Stainless steel pipe bends Ø 40.0 x 1.5 mm						
Outer pipe diameter	Wall thickness	Radius	Angle	Leg extension	Weight	Article number
40.0 mm	1.5 mm	75 mm	90°	100 mm	0.46 kg	104010001
40.0 mm	1.5 mm	75 mm	45°	100 mm	0.38 kg	104010002
40.0 mm	1.5 mm	100 mm	90°	100 mm	0.52 kg	104010104
40.0 mm	1.5 mm	100 mm	45°	100 mm	0.40 kg	104010105
40.0 mm	1.5 mm	250 mm	90°	100 mm	0.86 kg	104010201
40.0 mm	1.5 mm	250 mm	45°	100 mm	0.57 kg	104010202
40.0 mm	1.5 mm	380 mm	90°	100 mm	1.16 kg	104010303 ○
40.0 mm	1.5 mm	380 mm	45°	100 mm	0.72 kg	104010304 ○
40.0 mm	1.5 mm	500 mm	90°	100 mm	1.43 kg	104010520
40.0 mm	1.5 mm	500 mm	45°	100 mm	0.86 kg	104010521
40.0 mm	1.5 mm	250 mm	90°	200 mm	1.15 kg	104010203
40.0 mm	1.5 mm	250 mm	45°	200 mm	0.86 kg	104010204
40.0 mm	1.5 mm	380 mm	90°	200 mm	1.45 kg	104010301 ○
40.0 mm	1.5 mm	380 mm	45°	200 mm	1.01 kg	104010302 ○
40.0 mm	1.5 mm	500 mm	90°	200 mm	1.72 kg	104010501
40.0 mm	1.5 mm	500 mm	45°	200 mm	1.15 kg	104010502
40.0 mm	1.5 mm	800 mm	90°	200 mm	2.40 kg	104010801
40.0 mm	1.5 mm	800 mm	45°	200 mm	1.49 kg	104010802
40.0 mm	1.5 mm	1000 mm	90°	200 mm	2.86 kg	104010003
40.0 mm	1.5 mm	1000 mm	45°	200 mm	1.72 kg	104010006

Stainless steel pipe bends Ø 45.0 x 1.5 mm						
Outer pipe diameter	Wall thickness	Radius	Angle	Leg extension	Weight	Article number
45.0 mm	1.5 mm	100 mm	90°	50 mm	0.42 kg	104510101
45.0 mm	1.5 mm	100 mm	45°	50 mm	0.29 kg	104510102
45.0 mm	1.5 mm	75 mm	90°	100 mm	0.52 kg	104510001
45.0 mm	1.5 mm	75 mm	45°	100 mm	0.42 kg	104510002
45.0 mm	1.5 mm	300 mm	90°	200 mm	1.42 kg	104510301
45.0 mm	1.5 mm	300 mm	45°	200 mm	1.04 kg	104510302
45.0 mm	1.5 mm	500 mm	90°	200 mm	1.93 kg	104510501
45.0 mm	1.5 mm	500 mm	45°	200 mm	1.29 kg	104510502

thicker-walled and in other materials also available...

no stock article | available at short notice = ○

Stainless steel pipe bends Ø 48.3 x 2.0 mm

Outer pipe diameter	Wall thickness	Radius	Angle	Leg extension	Weight	Article number
○ 48.3 mm	2.0 mm	300 mm	90°	100 mm	1.55 kg	104810301
○ 48.3 mm	2.0 mm	300 mm	45°	100 mm	1.01 kg	104810302
○ 48.3 mm	2.0 mm	96 mm	90°	150 mm	1.04 kg	104810005
○ 48.3 mm	2.0 mm	96 mm	45°	150 mm	0.87 kg	104810006
48.3 mm	2.0 mm	500 mm	90°	200 mm	2.74 kg	104810501
48.3 mm	2.0 mm	500 mm	45°	200 mm	1.83 kg	104810502

Stainless steel pipe bends Ø 50.0 x 1.5 mm

Outer pipe diameter	Wall thickness	Radius	Angle	Leg extension	Weight	Article number
50.0 mm	1.5 mm	75 mm	90°	100 mm	0.58 kg	105010002
50.0 mm	1.5 mm	75 mm	45°	100 mm	0.47 kg	105010003
50.0 mm	1.5 mm	100 mm	90°	100 mm	0.65 kg	105010113
50.0 mm	1.5 mm	100 mm	45°	100 mm	0.51 kg	105010114
50.0 mm	1.5 mm	150 mm	90°	100 mm	0.79 kg	105010105
50.0 mm	1.5 mm	150 mm	45°	100 mm	0.58 kg	105010106
50.0 mm	1.5 mm	180 mm	90°	100 mm	0.88 kg	105010115
50.0 mm	1.5 mm	180 mm	45°	100 mm	0.62 kg	105010116
50.0 mm	1.5 mm	250 mm	90°	100 mm	1.08 kg	105010201
50.0 mm	1.5 mm	250 mm	60°	100 mm	0.84 kg	105010203
50.0 mm	1.5 mm	250 mm	45°	100 mm	0.72 kg	105010202
50.0 mm	1.5 mm	250 mm	30°	100 mm	0.60 kg	105010218
50.0 mm	1.5 mm	500 mm	90°	100 mm	1.79 kg	105010520
50.0 mm	1.5 mm	500 mm	45°	100 mm	1.08 kg	105010526
50.0 mm	1.5 mm	250 mm	90°	200 mm	1.44 kg	105010214
50.0 mm	1.5 mm	250 mm	45°	200 mm	1.09 kg	105010210
○ 50.0 mm	1.5 mm	300 mm	90°	200 mm	1.59 kg	105010301
○ 50.0 mm	1.5 mm	300 mm	45°	200 mm	1.16 kg	105010302
50.0 mm	1.5 mm	500 mm	90°	200 mm	2.16 kg	105010501
50.0 mm	1.5 mm	500 mm	60°	200 mm	1.68 kg	105010518
50.0 mm	1.5 mm	500 mm	45°	200 mm	1.44 kg	105010502
50.0 mm	1.5 mm	500 mm	30°	200 mm	1.20 kg	105010508
50.0 mm	1.5 mm	800 mm	90°	200 mm	3.02 kg	105010801
50.0 mm	1.5 mm	800 mm	45°	200 mm	1.87 kg	105010802
50.0 mm	1.5 mm	1000 mm	90°	200 mm	3.59 kg	105010009
50.0 mm	1.5 mm	1000 mm	45°	200 mm	2.16 kg	105010016

also in other angles available...

○ = no stock article | available at short notice

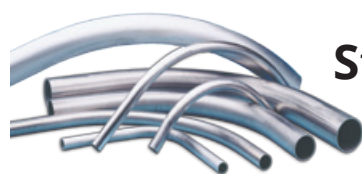

Stainless steel pipe bends

Material no. AISI 304 / 304 L

Stainless steel pipe bends Ø 50.0 x 2.0 mm						
Outer pipe diameter	Wall thickness	Radius	Angle	Leg extension	Weight	Article number
50.0 mm	2.0 mm	75 mm	90°	100 mm	0.76 kg	105010004
50.0 mm	2.0 mm	75 mm	45°	100 mm	0.62 kg	105010005
50.0 mm	2.0 mm	100 mm	90°	100 mm	0.86 kg	105010112 ○
50.0 mm	2.0 mm	100 mm	45°	100 mm	0.67 kg	105010119 ○
50.0 mm	2.0 mm	150 mm	90°	100 mm	1.05 kg	105010107
50.0 mm	2.0 mm	150 mm	45°	100 mm	0.76 kg	105010108
50.0 mm	2.0 mm	180 mm	90°	100 mm	1.16 kg	105010120 ○
50.0 mm	2.0 mm	180 mm	45°	100 mm	0.82 kg	105010121 ○
50.0 mm	2.0 mm	500 mm	90°	100 mm	2.36 kg	105010504 ○
50.0 mm	2.0 mm	500 mm	45°	100 mm	1.42 kg	105010505 ○
50.0 mm	2.0 mm	250 mm	90°	200 mm	1.90 kg	105010216
50.0 mm	2.0 mm	250 mm	45°	200 mm	1.43 kg	105010217
50.0 mm	2.0 mm	300 mm	90°	200 mm	2.09 kg	105010310 ○
50.0 mm	2.0 mm	300 mm	45°	200 mm	1.53 kg	105010311 ○
50.0 mm	2.0 mm	500 mm	90°	200 mm	2.84 kg	105010519
50.0 mm	2.0 mm	500 mm	45°	200 mm	1.90 kg	105010522
50.0 mm	2.0 mm	800 mm	90°	200 mm	3.98 kg	105010805
50.0 mm	2.0 mm	800 mm	45°	200 mm	2.47 kg	105010809
50.0 mm	2.0 mm	1000 mm	90°	200 mm	4.73 kg	105010008
50.0 mm	2.0 mm	1000 mm	45°	200 mm	2.84 kg	105010014

Stainless steel pipe bends Ø 50.8 x 1.5 mm						
Outer pipe diameter	Wall thickness	Radius	Angle	Leg extension	Weight	Article number
50,8 mm	1,5 mm	75 mm	90°	100 mm	0,59 kg	105110001 ○
50,8 mm	1,5 mm	75 mm	45°	100 mm	0,48 kg	105110002 ○
50,8 mm	1,5 mm	250 mm	90°	100 mm	1,10 kg	105110201 ○
50,8 mm	1,5 mm	250 mm	45°	100 mm	0,74 kg	105110202 ○
50,8 mm	1,5 mm	500 mm	90°	200 mm	2,20 kg	105110501 ○
50,8 mm	1,5 mm	500 mm	45°	200 mm	1,47 kg	105110502 ○
50,8 mm	1,5 mm	800 mm	90°	200 mm	3,08 kg	105110801 ○
50,8 mm	1,5 mm	800 mm	45°	200 mm	1,91 kg	105110802 ○

thicker-walled and in other materials also available...

no stock article | available at short notice = ○

Stainless steel pipe bends Ø 54.0 x 2.0 mm

Outer pipe diameter	Wall thickness	Radius	Angle	Leg extension	Weight	Article number
54.0 mm	2.0 mm	75 mm	90°	100 mm	0.83 kg	105410002
54.0 mm	2.0 mm	75 mm	45°	100 mm	0.67 kg	105410003
54.0 mm	2.0 mm	150 mm	90°	100 mm	1.13 kg	105410101
54.0 mm	2.0 mm	150 mm	45°	100 mm	0.83 kg	105410102
54.0 mm	2.0 mm	250 mm	90°	100 mm	1.54 kg	105410201
54.0 mm	2.0 mm	250 mm	45°	100 mm	1.03 kg	105410202
54.0 mm	2.0 mm	500 mm	90°	200 mm	3.08 kg	105410501
54.0 mm	2.0 mm	500 mm	45°	200 mm	2.06 kg	105410502
54.0 mm	2.0 mm	800 mm	90°	200 mm	4.31 kg	105410801
54.0 mm	2.0 mm	800 mm	45°	200 mm	2.67 kg	105410802
54.0 mm	2.0 mm	1000 mm	90°	200 mm	5.12 kg	105410005
54.0 mm	2.0 mm	1000 mm	45°	200 mm	3.08 kg	105410006

Stainless steel pipe bends Ø 60.3 x 1.5 mm

Outer pipe diameter	Wall thickness	Radius	Angle	Leg extension	Weight	Article number
60.3 mm	1.5 mm	500 mm	90°	100 mm	2.18 kg	106010519
60.3 mm	1.5 mm	500 mm	45°	100 mm	1.31 kg	106010520
60.3 mm	1.5 mm	100 mm	90°	150 mm	1.01 kg	106010112
60.3 mm	1.5 mm	100 mm	45°	150 mm	0.84 kg	106010113
60.3 mm	1.5 mm	115 mm	90°	150 mm	1.06 kg	106010110
60.3 mm	1.5 mm	115 mm	45°	150 mm	0.86 kg	106010111
60.3 mm	1.5 mm	800 mm	90°	150 mm	3.44 kg	106010810
60.3 mm	1.5 mm	800 mm	45°	150 mm	2.05 kg	106010811
60.3 mm	1.5 mm	250 mm	90°	200 mm	1.75 kg	106010207
60.3 mm	1.5 mm	250 mm	45°	200 mm	1.32 kg	106010208
60.3 mm	1.5 mm	300 mm	90°	200 mm	1.93 kg	106010306
60.3 mm	1.5 mm	300 mm	45°	200 mm	1.40 kg	106010307
60.3 mm	1.5 mm	500 mm	90°	200 mm	2.62 kg	106010510
60.3 mm	1.5 mm	500 mm	45°	200 mm	1.75 kg	106010511
60.3 mm	1.5 mm	1000 mm	90°	200 mm	4.36 kg	106010010
60.3 mm	1.5 mm	1000 mm	45°	200 mm	2.62 kg	106010011

also in other angles available...

○ = no stock article | available at short notice

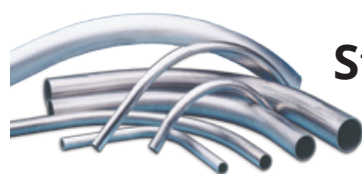

Stainless steel pipe bends

Material no. AISI 304 / 304 L

Stainless steel pipe bends Ø 60.3 x 2.0 mm						
Outer pipe diameter	Wall thickness	Radius	Angle	Leg extension	Weight	Article number
60.3 mm	2.0 mm	100 mm	90°	100 mm	1.04 kg	106010106
60.3 mm	2.0 mm	100 mm	45°	100 mm	0.81 kg	106010107
60.3 mm	2.0 mm	300 mm	90°	100 mm	1.96 kg	106010308
60.3 mm	2.0 mm	300 mm	45°	100 mm	1.27 kg	106010309
60.3 mm	2.0 mm	500 mm	90°	100 mm	2.88 kg	106010506
60.3 mm	2.0 mm	500 mm	45°	100 mm	1.73 kg	106010507
60.3 mm	2.0 mm	115 mm	90°	150 mm	1.40 kg	106010101
60.3 mm	2.0 mm	115 mm	45°	150 mm	1.14 kg	106010102
60.3 mm	2.0 mm	250 mm	90°	200 mm	2.31 kg	106010201
60.3 mm	2.0 mm	250 mm	45°	200 mm	1.74 kg	106010202
60.3 mm	2.0 mm	300 mm	90°	200 mm	2.54 kg	106010324 ○
60.3 mm	2.0 mm	300 mm	45°	200 mm	1.86 kg	106010325 ○
60.3 mm	2.0 mm	500 mm	90°	200 mm	3.46 kg	106010501
60.3 mm	2.0 mm	500 mm	45°	200 mm	2.31 kg	106010502
60.3 mm	2.0 mm	800 mm	90°	200 mm	4.84 kg	106010801
60.3 mm	2.0 mm	800 mm	45°	200 mm	3.00 kg	106010802
60.3 mm	2.0 mm	1000 mm	90°	200 mm	5.75 kg	106010001
60.3 mm	2.0 mm	1000 mm	45°	200 mm	3.46 kg	106010003

Stainless steel pipe bends Ø 63.5 x 2.0 mm						
Outer pipe diameter	Wall thickness	Radius	Angle	Leg extension	Weight	Article number
63.5 mm	2.0 mm	160 mm	90°	150 mm	1.70 kg	106310101
63.5 mm	2.0 mm	160 mm	45°	150 mm	1.31 kg	106310102
63.5 mm	2.0 mm	500 mm	90°	200 mm	3.65 kg	106310503
63.5 mm	2.0 mm	500 mm	45°	200 mm	2.44 kg	106310504
63.5 mm	2.0 mm	800 mm	90°	200 mm	5.10 kg	106310801
63.5 mm	2.0 mm	800 mm	45°	200 mm	3.17 kg	106310802
63.5 mm	2.0 mm	1000 mm	90°	200 mm	6.07 kg	106310001 ○
63.5 mm	2.0 mm	1000 mm	45°	200 mm	3.65 kg	106310002 ○

thicker-walled and in other materials also available...

no stock article | available at short notice = ○

Stainless steel pipe bends Ø 65.0 x 1.5 mm

Outer pipe diameter	Wall thickness	Radius	Angle	Leg extension	Weight	Article number
65.0 mm	1.5 mm	115 mm	90°	150 mm	1.13 kg	106510110
65.0 mm	1.5 mm	115 mm	45°	150 mm	0.92 kg	106510111
65.0 mm	1.5 mm	250 mm	90°	200 mm	1.87 kg	106510203
65.0 mm	1.5 mm	250 mm	45°	200 mm	1.40 kg	106510207
○ 65.0 mm	1.5 mm	300 mm	90°	200 mm	2.05 kg	106510305
○ 65.0 mm	1.5 mm	300 mm	45°	200 mm	1.50 kg	106510306
65.0 mm	1.5 mm	500 mm	90°	200 mm	2.79 kg	106510504
65.0 mm	1.5 mm	500 mm	45°	200 mm	1.87 kg	106510505
65.0 mm	1.5 mm	800 mm	90°	200 mm	3.90 kg	106510803
65.0 mm	1.5 mm	800 mm	45°	200 mm	2.42 kg	106510807
65.0 mm	1.5 mm	1000 mm	90°	200 mm	4.64 kg	106510001
○ 65.0 mm	1.5 mm	1000 mm	45°	200 mm	2.79 kg	106510007

Stainless steel pipe bends Ø 65.0 x 2.0 mm

Outer pipe diameter	Wall thickness	Radius	Angle	Leg extension	Weight	Article number
65.0 mm	2.0 mm	115 mm	90°	150 mm	1.52 kg	106510101
65.0 mm	2.0 mm	115 mm	45°	150 mm	1.23 kg	106510102
65.0 mm	2.0 mm	250 mm	90°	200 mm	2.50 kg	106510201
65.0 mm	2.0 mm	250 mm	45°	200 mm	1.88 kg	106510202
○ 65.0 mm	2.0 mm	300 mm	90°	200 mm	2.75 kg	106510301
○ 65.0 mm	2.0 mm	300 mm	45°	200 mm	2.01 kg	106510302
65.0 mm	2.0 mm	500 mm	90°	200 mm	3.74 kg	106510501
65.0 mm	2.0 mm	500 mm	45°	200 mm	2.50 kg	106510502
65.0 mm	2.0 mm	800 mm	90°	200 mm	5.23 kg	106510801
65.0 mm	2.0 mm	800 mm	45°	200 mm	3.24 kg	106510802
65.0 mm	2.0 mm	1000 mm	90°	200 mm	6.22 kg	106510002
65.0 mm	2.0 mm	1000 mm	45°	200 mm	3.74 kg	106510004

also in other angles available...

○ = no stock article | available at short notice

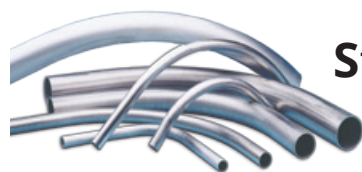

Stainless steel pipe bends

Material no. AISI 304 / 304 L

Stainless steel pipe bends Ø 70.0 x 2.0 mm						
Outer pipe diameter	Wall thickness	Radius	Angle	Leg extension	Weight	Article number
70.0 mm	2.0 mm	95 mm	90°	180 mm	1.73 kg	107010003
70.0 mm	2.0 mm	95 mm	45°	180 mm	1.48 kg	107010004
70.0 mm	2.0 mm	150 mm	90°	200 mm	2.16 kg	107010106
70.0 mm	2.0 mm	150 mm	45°	200 mm	1.76 kg	107010107
70.0 mm	2.0 mm	250 mm	90°	200 mm	2.70 kg	107010201
70.0 mm	2.0 mm	250 mm	45°	200 mm	2.03 kg	107010202
70.0 mm	2.0 mm	400 mm	90°	200 mm	3.50 kg	107010401
70.0 mm	2.0 mm	400 mm	45°	200 mm	2.43 kg	107010402
70.0 mm	2.0 mm	500 mm	90°	200 mm	4.03 kg	107010501
70.0 mm	2.0 mm	500 mm	45°	200 mm	2.70 kg	107010502
70.0 mm	2.0 mm	800 mm	90°	200 mm	5.63 kg	107010801
70.0 mm	2.0 mm	800 mm	45°	200 mm	3.50 kg	107010802
70.0 mm	2.0 mm	1000 mm	90°	200 mm	6.70 kg	107010001
70.0 mm	2.0 mm	1000 mm	45°	200 mm	4.03 kg	107010005

Stainless steel pipe bends Ø 76.1 x 2.0 mm						
Outer pipe diameter	Wall thickness	Radius	Angle	Leg extension	Weight	Article number
76.1 mm	2.0 mm	180 mm	90°	200 mm	2.53 kg	107610101
76.1 mm	2.0 mm	180 mm	45°	200 mm	2.00 kg	107610102
76.1 mm	2.0 mm	250 mm	90°	200 mm	2.93 kg	107610201
76.1 mm	2.0 mm	250 mm	45°	200 mm	2.21 kg	107610202
76.1 mm	2.0 mm	400 mm	90°	200 mm	3.80 kg	107610401
76.1 mm	2.0 mm	400 mm	45°	200 mm	2.64 kg	107610402
76.1 mm	2.0 mm	500 mm	90°	200 mm	4.39 kg	107610502
76.1 mm	2.0 mm	500 mm	45°	200 mm	2.93 kg	107610503
76.1 mm	2.0 mm	800 mm	90°	200 mm	6.13 kg	107610801
76.1 mm	2.0 mm	800 mm	45°	200 mm	3.80 kg	107610802
76.1 mm	2.0 mm	1000 mm	90°	200 mm	7.29 kg	107610001
76.1 mm	2.0 mm	1000 mm	45°	200 mm	4.39 kg	107610002

thicker-walled and in other materials also available...

no stock article | available at short notice = ○

Stainless steel pipe bends Ø 76.1 x 2.6 mm

Outer pipe diameter	Wall thickness	Radius	Angle	Leg extension	Weight	Article number
○ 76.1 mm	2.6 mm	500 mm	90°	200 mm	5.46 kg	107610516
○ 76.1 mm	2.6 mm	500 mm	45°	200 mm	3.65 kg	107610517
○ 76.1 mm	2.6 mm	800 mm	90°	200 mm	7.64 kg	107610811
○ 76.1 mm	2.6 mm	800 mm	45°	200 mm	4.74 kg	107610812
○ 76.1 mm	2.6 mm	1000 mm	90°	200 mm	9.09 kg	107610011
○ 76.1 mm	2.6 mm	1000 mm	45°	200 mm	5.46 kg	107610012

Stainless steel pipe bends Ø 76.1 x 3.0 mm

Outer pipe diameter	Wall thickness	Radius	Angle	Leg extension	Weight	Article number
○ 76.1 mm	3.0 mm	500 mm	90°	200 mm	6.51 kg	107610510
○ 76.1 mm	3.0 mm	500 mm	45°	200 mm	4.35 kg	107610505
○ 76.1 mm	3.0 mm	800 mm	90°	200 mm	9.09 kg	107610808
○ 76.1 mm	3.0 mm	800 mm	45°	200 mm	5.65 kg	107610813
○ 76.1 mm	3.0 mm	1000 mm	90°	200 mm	10.82 kg	107610005
○ 76.1 mm	3.0 mm	1000 mm	45°	200 mm	6.51 kg	107610015

Stainless steel pipe bends Ø 80.0 x 1.5 mm

Outer pipe diameter	Wall thickness	Radius	Angle	Leg extension	Weight	Article number
80.0 mm	1.5 mm	150 mm	90°	200 mm	1.88 kg	108010105
80.0 mm	1.5 mm	150 mm	45°	200 mm	1.53 kg	108010106
80.0 mm	1.5 mm	250 mm	90°	200 mm	2.34 kg	108010203
80.0 mm	1.5 mm	250 mm	45°	200 mm	1.76 kg	108010204
80.0 mm	1.5 mm	500 mm	90°	200 mm	3.50 kg	108010503
80.0 mm	1.5 mm	500 mm	45°	200 mm	2.34 kg	108010510
80.0 mm	1.5 mm	800 mm	90°	200 mm	4.89 kg	108010808
80.0 mm	1.5 mm	800 mm	45°	200 mm	3.03 kg	108010807
80.0 mm	1.5 mm	1000 mm	90°	200 mm	5.81 kg	108010005
80.0 mm	1.5 mm	1000 mm	45°	200 mm	3.50 kg	108010006
○ 80.0 mm	1.5 mm	1200 mm	90°	200 mm	6.74 kg	108010X05
○ 80.0 mm	1.5 mm	1200 mm	45°	200 mm	3.96 kg	108010X06
○ 80.0 mm	1.5 mm	1500 mm	90°	200 mm	8.13 kg	108010X13
○ 80.0 mm	1.5 mm	1500 mm	45°	200 mm	4.66 kg	108010X14

also in other angles available...

○ = no stock article | available at short notice

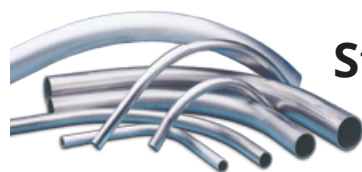

Stainless steel pipe bends

Material no. AISI 304 / 304 L

Stainless steel pipe bends Ø 80.0 x 2.0 mm						
Outer pipe diameter	Wall thickness	Radius	Angle	Leg extension	Weight	Article number
80.0 mm	2.0 mm	150 mm	90°	200 mm	2.49 kg	108010101
80.0 mm	2.0 mm	150 mm	45°	200 mm	2.02 kg	108010102
80.0 mm	2.0 mm	250 mm	90°	200 mm	3.10 kg	108010201
80.0 mm	2.0 mm	250 mm	45°	200 mm	2.33 kg	108010202
80.0 mm	2.0 mm	500 mm	90°	200 mm	4.63 kg	108010501
80.0 mm	2.0 mm	500 mm	45°	200 mm	3.10 kg	108010502
80.0 mm	2.0 mm	800 mm	90°	200 mm	6.48 kg	108010801
80.0 mm	2.0 mm	800 mm	45°	200 mm	4.02 kg	108010802
80.0 mm	2.0 mm	1000 mm	90°	200 mm	7.71 kg	108010001
80.0 mm	2.0 mm	1000 mm	45°	200 mm	4.63 kg	108010002
80.0 mm	2.0 mm	1200 mm	90°	200 mm	8.93 kg	108010X01 ○
80.0 mm	2.0 mm	1200 mm	45°	200 mm	5.25 kg	108010X02 ○
80.0 mm	2.0 mm	1500 mm	90°	200 mm	10.78 kg	108010X11 ○
80.0 mm	2.0 mm	1500 mm	45°	200 mm	6.17 kg	108010X12 ○

Stainless steel pipe bends Ø 80.0 x 2.5 mm						
Outer pipe diameter	Wall thickness	Radius	Angle	Leg extension	Weight	Article number
80.0 mm	2.5 mm	500 mm	90°	200 mm	5.75 kg	108010520 ○
80.0 mm	2.5 mm	500 mm	45°	200 mm	3.84 kg	108010521 ○
80.0 mm	2.5 mm	800 mm	90°	200 mm	8.03 kg	108010820 ○
80.0 mm	2.5 mm	800 mm	45°	200 mm	4.99 kg	108010821 ○
80.0 mm	2.5 mm	1000 mm	90°	200 mm	9.56 kg	108010010 ○
80.0 mm	2.5 mm	1000 mm	45°	200 mm	5.75 kg	108010011 ○
80.0 mm	2.5 mm	1200 mm	90°	200 mm	11.08 kg	108010X03 ○
80.0 mm	2.5 mm	1200 mm	45°	200 mm	6.51 kg	108010X04 ○
80.0 mm	2.5 mm	1500 mm	90°	200 mm	13.37 kg	108010X15 ○
80.0 mm	2.5 mm	1500 mm	45°	200 mm	7.65 kg	108010X16 ○

thicker-walled and in other materials also available...

no stock article | available at short notice = ○

Stainless steel pipe bends Ø 84.0 x 2.0 mm

Outer pipe diameter	Wall thickness	Radius	Angle	Leg extension	Weight	Article number
84.0 mm	2.0 mm	150 mm	90°	200 mm	2.61 kg	108410101
84.0 mm	2.0 mm	150 mm	45°	200 mm	2.13 kg	108410102
84.0 mm	2.0 mm	250 mm	90°	200 mm	3.26 kg	108410201
84.0 mm	2.0 mm	250 mm	45°	200 mm	2.45 kg	108410202
84.0 mm	2.0 mm	500 mm	90°	200 mm	4.87 kg	108410501
84.0 mm	2.0 mm	500 mm	45°	200 mm	3.26 kg	108410502
84.0 mm	2.0 mm	800 mm	90°	200 mm	6.81 kg	108410801
84.0 mm	2.0 mm	800 mm	45°	200 mm	4.23 kg	108410802
84.0 mm	2.0 mm	1000 mm	90°	200 mm	8.10 kg	108410001
84.0 mm	2.0 mm	1000 mm	45°	200 mm	4.87 kg	108410002

Stainless steel pipe bends Ø 85.0 x 2.0 mm

Outer pipe diameter	Wall thickness	Radius	Angle	Leg extension	Weight	Article number
85.0 mm	2.0 mm	150 mm	90°	200 mm	2.64 kg	108510101
85.0 mm	2.0 mm	150 mm	45°	200 mm	2.15 kg	108510102
85.0 mm	2.0 mm	500 mm	90°	200 mm	4.93 kg	108510501
85.0 mm	2.0 mm	500 mm	45°	200 mm	3.30 kg	108510502
85.0 mm	2.0 mm	800 mm	90°	200 mm	6.89 kg	108510801
85.0 mm	2.0 mm	800 mm	45°	200 mm	4.28 kg	108510802
85.0 mm	2.0 mm	1000 mm	90°	200 mm	8.20 kg	108510001
85.0 mm	2.0 mm	1000 mm	45°	200 mm	4.93 kg	108510004

also in other angles available...

○ = no stock article | available at short notice

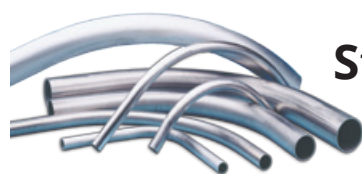

Stainless steel pipe bends

Material no. AISI 304 / 304 L

Stainless steel pipe bends Ø 88.9 x 2.0 mm						
Outer pipe diameter	Wall thickness	Radius	Angle	Leg extension	Weight	Article number
88.9 mm	2.0 mm	150 mm	90°	200 mm	2.76 kg	108810101
88.9 mm	2.0 mm	150 mm	45°	200 mm	2.25 kg	108810102
88.9 mm	2.0 mm	250 mm	90°	200 mm	3.45 kg	108810201
88.9 mm	2.0 mm	250 mm	45°	200 mm	2.59 kg	108810202
88.9 mm	2.0 mm	385 mm	90°	200 mm	4.37 kg	108810301 ○
88.9 mm	2.0 mm	385 mm	45°	200 mm	3.06 kg	108810302 ○
88.9 mm	2.0 mm	500 mm	90°	200 mm	5.16 kg	108810501
88.9 mm	2.0 mm	500 mm	45°	200 mm	3.45 kg	108810502
88.9 mm	2.0 mm	800 mm	90°	200 mm	7.21 kg	108810801
88.9 mm	2.0 mm	800 mm	45°	200 mm	4.47 kg	108810802
88.9 mm	2.0 mm	1000 mm	90°	200 mm	8.57 kg	108810003
88.9 mm	2.0 mm	1000 mm	45°	200 mm	5.16 kg	108810013
88.9 mm	2.0 mm	1200 mm	90°	200 mm	9.94 kg	108810X15 ○
88.9 mm	2.0 mm	1200 mm	45°	200 mm	5.84 kg	108810X16 ○

Stainless steel pipe bends Ø 88.9 x 2.6 mm						
Outer pipe diameter	Wall thickness	Radius	Angle	Leg extension	Weight	Article number
88.9 mm	2.6 mm	500 mm	90°	200 mm	6.65 kg	108810509 ○
88.9 mm	2.6 mm	500 mm	45°	200 mm	4.45 kg	108810514 ○
88.9 mm	2.6 mm	800 mm	90°	200 mm	9.29 kg	108810804 ○
88.9 mm	2.6 mm	800 mm	45°	200 mm	5.77 kg	108810808 ○
88.9 mm	2.6 mm	1000 mm	90°	200 mm	11.06 kg	108810008 ○
88.9 mm	2.6 mm	1000 mm	45°	200 mm	6.65 kg	108810012 ○
88.9 mm	2.6 mm	1200 mm	90°	200 mm	12.82 kg	108810X20 ○
88.9 mm	2.6 mm	1200 mm	45°	200 mm	7.53 kg	108810X21 ○

thicker-walled and in other materials also available...

no stock article | available at short notice = ○

Stainless steel pipe bends Ø 88.9 x 3.0 mm

Outer pipe diameter	Wall thickness	Radius	Angle	Leg extension	Weight	Article number
○ 88.9 mm	3.0 mm	500 mm	90°	200 mm	7.65 kg	108810506
○ 88.9 mm	3.0 mm	500 mm	45°	200 mm	5.11 kg	108810512
○ 88.9 mm	3.0 mm	800 mm	90°	200 mm	10.69 kg	108810803
○ 88.9 mm	3.0 mm	800 mm	45°	200 mm	6.63 kg	108810815
○ 88.9 mm	3.0 mm	1000 mm	90°	200 mm	12.71 kg	108810011
○ 88.9 mm	3.0 mm	1000 mm	45°	200 mm	7.65 kg	108810015
○ 88.9 mm	3.0 mm	1200 mm	90°	200 mm	14.74 kg	108810X02
○ 88.9 mm	3.0 mm	1200 mm	45°	200 mm	8.66 kg	108810X19

Stainless steel pipe bends Ø 88.9 x 4.0 mm

Outer pipe diameter	Wall thickness	Radius	Angle	Leg extension	Weight	Article number
○ 88.9 mm	4.0 mm	500 mm	90°	200 mm	10.09 kg	108810503
○ 88.9 mm	4.0 mm	500 mm	45°	200 mm	6.75 kg	108810513
○ 88.9 mm	4.0 mm	800 mm	90°	200 mm	14.10 kg	108810820
○ 88.9 mm	4.0 mm	800 mm	45°	200 mm	8.75 kg	108810823
○ 88.9 mm	4.0 mm	1000 mm	90°	200 mm	16.77 kg	108810030
○ 88.9 mm	4.0 mm	1000 mm	45°	200 mm	10.09 kg	108810031
○ 88.9 mm	4.0 mm	1200 mm	90°	200 mm	19.44 kg	108810X25
○ 88.9 mm	4.0 mm	1200 mm	45°	200 mm	11.42 kg	108810X26

Stainless steel pipe bends Ø 100.0 x 1.5 mm

Outer pipe diameter	Wall thickness	Radius	Angle	Leg extension	Weight	Article number
100,0 mm	1,5 mm	145 mm	90°	200 mm	2,32 kg	110010102
100,0 mm	1,5 mm	145 mm	45°	200 mm	1,90 kg	110010103
○ 100,0 mm	1,5 mm	250 mm	90°	200 mm	2,93 kg	110010201
○ 100,0 mm	1,5 mm	250 mm	45°	200 mm	2,21 kg	110010202
100,0 mm	1,5 mm	500 mm	90°	200 mm	4,39 kg	110010501
100,0 mm	1,5 mm	500 mm	45°	200 mm	2,93 kg	110010502
100,0 mm	1,5 mm	800 mm	90°	200 mm	6,13 kg	110010801
100,0 mm	1,5 mm	800 mm	45°	200 mm	3,80 kg	110010803
100,0 mm	1,5 mm	1000 mm	90°	200 mm	7,29 kg	110010002
100,0 mm	1,5 mm	1000 mm	45°	200 mm	4,39 kg	110010003
○ 100,0 mm	1,5 mm	1200 mm	90°	200 mm	8,45 kg	110010X10
○ 100,0 mm	1,5 mm	1200 mm	45°	200 mm	4,97 kg	110010X11
○ 100,0 mm	1,5 mm	1500 mm	90°	200 mm	10,20 kg	110010X02
○ 100,0 mm	1,5 mm	1500 mm	45°	200 mm	5,84 kg	110010X03

also in other angles available...

○ = no stock article | available at short notice

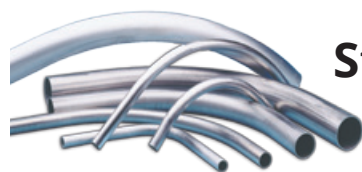

Stainless steel pipe bends

Material no. AISI 304 / 304 L

Stainless steel pipe bends Ø 101.6 x 2.0 mm						
Outer pipe diameter	Wall thickness	Radius	Angle	Leg extension	Weight	Article number
101.6 mm	2.0 mm	150 mm	90°	200 mm	3.17 kg	110110104
101.6 mm	2.0 mm	150 mm	45°	200 mm	2.58 kg	110110105
101.6 mm	2.0 mm	500 mm	90°	200 mm	5.90 kg	110110501
101.6 mm	2.0 mm	500 mm	45°	200 mm	3.95 kg	110110502
101.6 mm	2.0 mm	800 mm	90°	200 mm	8.25 kg	110110801
101.6 mm	2.0 mm	800 mm	45°	200 mm	5.12 kg	110110802
101.6 mm	2.0 mm	1000 mm	90°	200 mm	9.81 kg	110110001
101.6 mm	2.0 mm	1000 mm	45°	200 mm	5.90 kg	110110002
101.6 mm	2.0 mm	1200 mm	90°	200 mm	11.38 kg	110110X05 ○
101.6 mm	2.0 mm	1200 mm	45°	200 mm	6.69 kg	110110X06 ○

Stainless steel pipe bends Ø 101.6 x 3.0 mm						
Outer pipe diameter	Wall thickness	Radius	Angle	Leg extension	Weight	Article number
101.6 mm	3.0 mm	500 mm	90°	200 mm	8.78 kg	110110515 ○
101.6 mm	3.0 mm	500 mm	45°	200 mm	5.87 kg	110110516 ○
101.6 mm	3.0 mm	800 mm	90°	200 mm	12.28 kg	110110810 ○
101.6 mm	3.0 mm	800 mm	45°	200 mm	7.62 kg	110110811 ○
101.6 mm	3.0 mm	1000 mm	90°	200 mm	14.60 kg	110110009 ○
101.6 mm	3.0 mm	1000 mm	45°	200 mm	8.78 kg	110110011 ○
101.6 mm	3.0 mm	1200 mm	90°	200 mm	16.93 kg	110110X03 ○
101.6 mm	3.0 mm	1200 mm	45°	200 mm	9.95 kg	110110X07 ○

Stainless steel pipe bends Ø 101.6 x 4.0 mm						
Outer pipe diameter	Wall thickness	Radius	Angle	Leg extension	Weight	Article number
101.6 mm	4.0 mm	500 mm	90°	200 mm	11.58 kg	110110510 ○
101.6 mm	4.0 mm	500 mm	45°	200 mm	7.74 kg	110110511 ○
101.6 mm	4.0 mm	800 mm	90°	200 mm	16.19 kg	110110805 ○
101.6 mm	4.0 mm	800 mm	45°	200 mm	10.05 kg	110110806 ○
101.6 mm	4.0 mm	1000 mm	90°	200 mm	19.25 kg	110110020 ○
101.6 mm	4.0 mm	1000 mm	45°	200 mm	11.58 kg	110110021 ○
101.6 mm	4.0 mm	1200 mm	90°	200 mm	22.32 kg	110110X10 ○
101.6 mm	4.0 mm	1200 mm	45°	200 mm	13.12 kg	110110X11 ○

thicker-walled and in other materials also available...

no stock article | available at short notice = ○

Stainless steel pipe bends Ø 104.0 x 2.0 mm

Outer pipe diameter	Wall thickness	Radius	Angle	Leg extension	Weight	Article number
104.0 mm	2.0 mm	150 mm	90°	250 mm	3.76 kg	110410101
104.0 mm	2.0 mm	150 mm	45°	250 mm	3.16 kg	110410102
104.0 mm	2.0 mm	500 mm	90°	200 mm	6.06 kg	110410502
104.0 mm	2.0 mm	500 mm	45°	200 mm	4.05 kg	110410503
104.0 mm	2.0 mm	800 mm	90°	200 mm	8.47 kg	110410801
104.0 mm	2.0 mm	800 mm	45°	200 mm	5.25 kg	110410802
104.0 mm	2.0 mm	1000 mm	90°	200 mm	10.07 kg	110410001
104.0 mm	2.0 mm	1000 mm	45°	200 mm	6.06 kg	110410002
○ 104.0 mm	2.0 mm	1200 mm	90°	200 mm	11.68 kg	110410X03
○ 104.0 mm	2.0 mm	1200 mm	45°	200 mm	6.86 kg	110410X04
○ 104.0 mm	2.0 mm	1500 mm	90°	200 mm	14.08 kg	110410X01
○ 104.0 mm	2.0 mm	1500 mm	45°	200 mm	8.06 kg	110410X08

Stainless steel pipe bends Ø 108.0 x 2.0 mm

Outer pipe diameter	Wall thickness	Radius	Angle	Leg extension	Weight	Article number
108.0 mm	2.0 mm	150 mm	90°	250 mm	3.91 kg	110810101
108.0 mm	2.0 mm	150 mm	45°	250 mm	3.28 kg	110810102
108.0 mm	2.0 mm	500 mm	90°	200 mm	6.29 kg	110810502
108.0 mm	2.0 mm	500 mm	45°	200 mm	4.21 kg	110810503
108.0 mm	2.0 mm	800 mm	90°	200 mm	8.80 kg	110810808
108.0 mm	2.0 mm	800 mm	45°	200 mm	5.46 kg	110810809
108.0 mm	2.0 mm	1000 mm	90°	200 mm	10.46 kg	110810011
108.0 mm	2.0 mm	1000 mm	45°	200 mm	6.29 kg	110810012
○ 108.0 mm	2.0 mm	1200 mm	90°	200 mm	12.13 kg	110810X01
○ 108.0 mm	2.0 mm	1200 mm	45°	200 mm	7.13 kg	110810X02

Stainless steel pipe bends Ø 108.0 x 3.0 mm

Outer pipe diameter	Wall thickness	Radius	Angle	Leg extension	Weight	Article number
○ 108.0 mm	3.0 mm	500 mm	90°	200 mm	9.35 kg	110810505
○ 108.0 mm	3.0 mm	500 mm	45°	200 mm	6.25 kg	110810507
○ 108.0 mm	3.0 mm	800 mm	90°	200 mm	13.07 kg	110810802
○ 108.0 mm	3.0 mm	800 mm	45°	200 mm	8.11 kg	110810803
○ 108.0 mm	3.0 mm	1000 mm	90°	200 mm	15.55 kg	110810003
○ 108.0 mm	3.0 mm	1000 mm	45°	200 mm	9.35 kg	110810004
○ 108.0 mm	3.0 mm	1200 mm	90°	200 mm	18.03 kg	110810X05
○ 108.0 mm	3.0 mm	1200 mm	45°	200 mm	10.59 kg	110810X06

also in other angles available...

○ = no stock article | available at short notice

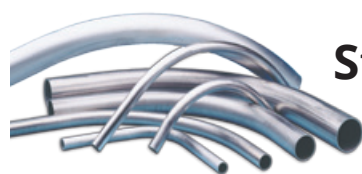

Stainless steel pipe bends

Material no. AISI 304 / 304 L

Stainless steel pipe bends Ø 110.0 x 2.0 mm						
Outer pipe diameter	Wall thickness	Radius	Angle	Leg extension	Weight	Article number
110.0 mm	2.0 mm	800 mm	90°	200 mm	8.96 kg	111010801
110.0 mm	2.0 mm	800 mm	45°	200 mm	5.56 kg	111010802 ○
110.0 mm	2.0 mm	1000 mm	90°	200 mm	10.66 kg	111010001 ○
110.0 mm	2.0 mm	1000 mm	45°	200 mm	6.41 kg	111010002 ○
110.0 mm	2.0 mm	1200 mm	90°	200 mm	12.36 kg	111010X01 ○
110.0 mm	2.0 mm	1200 mm	45°	200 mm	7.26 kg	111010X02 ○

Stainless steel pipe bends Ø 114.3 x 2.0 mm						
Outer pipe diameter	Wall thickness	Radius	Angle	Leg extension	Weight	Article number
114.3 mm	2.0 mm	150 mm	90°	200 mm	3.57 kg	111410101
114.3 mm	2.0 mm	150 mm	45°	200 mm	2.91 kg	111410102
114.3 mm	2.0 mm	500 mm	90°	200 mm	6.66 kg	111410503
114.3 mm	2.0 mm	500 mm	45°	200 mm	4.45 kg	111410516
114.3 mm	2.0 mm	800 mm	90°	200 mm	9.31 kg	111410802
114.3 mm	2.0 mm	800 mm	45°	200 mm	5.78 kg	111410803
114.3 mm	2.0 mm	1000 mm	90°	200 mm	11.08 kg	111410001
114.3 mm	2.0 mm	1000 mm	45°	200 mm	6.66 kg	111410002
114.3 mm	2.0 mm	1200 mm	90°	200 mm	12.84 kg	111410X06 ○
114.3 mm	2.0 mm	1200 mm	45°	200 mm	7.54 kg	111410X07 ○

Stainless steel pipe bends Ø 114.3 x 2.6 mm						
Outer pipe diameter	Wall thickness	Radius	Angle	Leg extension	Weight	Article number
114.3 mm	2.6 mm	500 mm	90°	200 mm	8.62 kg	111410501 ○
114.3 mm	2.6 mm	500 mm	45°	200 mm	5.76 kg	111410502 ○
114.3 mm	2.6 mm	800 mm	90°	200 mm	12.04 kg	111410811 ○
114.3 mm	2.6 mm	800 mm	45°	200 mm	7.48 kg	111410817 ○
114.3 mm	2.6 mm	1000 mm	90°	200 mm	14.33 kg	111410003 ○
114.3 mm	2.6 mm	1000 mm	45°	200 mm	8.62 kg	111410004 ○
114.3 mm	2.6 mm	1200 mm	90°	200 mm	16.61 kg	111410X20 ○
114.3 mm	2.6 mm	1200 mm	45°	200 mm	9.76 kg	111410X21 ○

thicker-walled and in other materials also available...

no stock article | available at short notice = ○

Stainless steel pipe bends Ø 114.3 x 3.0 mm

Outer pipe diameter	Wall thickness	Radius	Angle	Leg extension	Weight	Article number
○ 114.3 mm	3.0 mm	500 mm	90°	200 mm	9.91 kg	111410504
○ 114.3 mm	3.0 mm	500 mm	45°	200 mm	6.63 kg	111410520
○ 114.3 mm	3.0 mm	800 mm	90°	200 mm	13.85 kg	111410805
○ 114.3 mm	3.0 mm	800 mm	45°	200 mm	8.60 kg	111410820
○ 114.3 mm	3.0 mm	1000 mm	90°	200 mm	16.48 kg	111410013
○ 114.3 mm	3.0 mm	1000 mm	45°	200 mm	9.91 kg	111410023
○ 114.3 mm	3.0 mm	1200 mm	90°	200 mm	19.10 kg	111410X30
○ 114.3 mm	3.0 mm	1200 mm	45°	200 mm	11.22 kg	111410X31

Stainless steel pipe bends Ø 114.3 x 3.6 mm

Outer pipe diameter	Wall thickness	Radius	Angle	Leg extension	Weight	Article number
○ 114.3 mm	3.6 mm	500 mm	90°	200 mm	11.83 kg	111410530
○ 114.3 mm	3.6 mm	500 mm	45°	200 mm	7.91 kg	111410531
○ 114.3 mm	3.6 mm	800 mm	90°	200 mm	16.53 kg	111410819
○ 114.3 mm	3.6 mm	800 mm	45°	200 mm	10.26 kg	111410821
○ 114.3 mm	3.6 mm	1000 mm	90°	200 mm	19.67 kg	111410022
○ 114.3 mm	3.6 mm	1000 mm	45°	200 mm	11.83 kg	111410026
○ 114.3 mm	3.6 mm	1200 mm	90°	200 mm	22.80 kg	111410X35
○ 114.3 mm	3.6 mm	1200 mm	45°	200 mm	13.40 kg	111410X36

Stainless steel pipe bends Ø 114.3 x 4.0 mm

Outer pipe diameter	Wall thickness	Radius	Angle	Leg extension	Weight	Article number
○ 114.3 mm	4.0 mm	500 mm	90°	200 mm	13.10 kg	111410540
○ 114.3 mm	4.0 mm	500 mm	45°	200 mm	8.76 kg	111410541
○ 114.3 mm	4.0 mm	800 mm	90°	200 mm	18.31 kg	111410840
○ 114.3 mm	4.0 mm	800 mm	45°	200 mm	11.36 kg	111410841
○ 114.3 mm	4.0 mm	1000 mm	90°	200 mm	21.78 kg	111410018
○ 114.3 mm	4.0 mm	1000 mm	45°	200 mm	13.10 kg	111410027
○ 114.3 mm	4.0 mm	1200 mm	90°	200 mm	25.25 kg	111410X40
○ 114.3 mm	4.0 mm	1200 mm	45°	200 mm	14.83 kg	111410X41

also in other angles available...

○ = no stock article | available at short notice

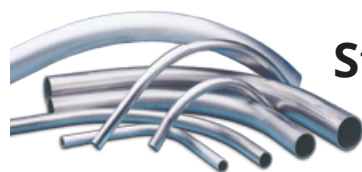

Stainless steel pipe bends

Material no. AISI 304 / 304 L

Stainless steel pipe bends Ø 125.0 x 2.0 mm						
Outer pipe diameter	Wall thickness	Radius	Angle	Leg extension	Weight	Article number
125.0 mm	2.0 mm	500 mm	90°	200 mm	7.30 kg	112510501 ○
125.0 mm	2.0 mm	500 mm	45°	200 mm	4.88 kg	112510502 ○
125.0 mm	2.0 mm	800 mm	90°	200 mm	10.20 kg	112510801 ○
125.0 mm	2.0 mm	800 mm	45°	200 mm	6.33 kg	112510802 ○
125.0 mm	2.0 mm	1000 mm	90°	200 mm	12.14 kg	112510001 ○
125.0 mm	2.0 mm	1000 mm	45°	200 mm	7.30 kg	112510002 ○

Stainless steel pipe bends Ø 128.0 x 1.5 mm						
Outer pipe diameter	Wall thickness	Radius	Angle	Leg extension	Weight	Article number
128.0 mm	1.5 mm	500 mm	90°	200 mm	5.63 kg	112810505
128.0 mm	1.5 mm	500 mm	45°	200 mm	3.77 kg	112810502
128.0 mm	1.5 mm	800 mm	90°	200 mm	7.87 kg	112810801
128.0 mm	1.5 mm	800 mm	45°	200 mm	4.88 kg	112810802

Stainless steel pipe bends Ø 129.0 x 2.0 mm						
Outer pipe diameter	Wall thickness	Radius	Angle	Leg extension	Weight	Article number
129.0 mm	2.0 mm	500 mm	90°	200 mm	7.54 kg	112910505
129.0 mm	2.0 mm	500 mm	45°	200 mm	5.04 kg	112910506
129.0 mm	2.0 mm	800 mm	90°	200 mm	10.54 kg	112910803
129.0 mm	2.0 mm	800 mm	45°	200 mm	6.54 kg	112910804
129.0 mm	2.0 mm	1000 mm	90°	200 mm	12.53 kg	112910002
129.0 mm	2.0 mm	1000 mm	45°	200 mm	7.54 kg	112910003
129.0 mm	2.0 mm	1200 mm	90°	200 mm	14.53 kg	112910X09 ○
129.0 mm	2.0 mm	1200 mm	45°	200 mm	8.54 kg	112910X12 ○
129.0 mm	2.0 mm	1500 mm	90°	200 mm	17.53 kg	112910X15 ○
129.0 mm	2.0 mm	1500 mm	45°	200 mm	10.04 kg	112910X16 ○

thicker-walled and in other materials also available...

no stock article | available at short notice = ○

Stainless steel pipe bends Ø 133.0 x 2.0 mm

Outer pipe diameter	Wall thickness	Radius	Angle	Leg extension	Weight	Article number
○ 133.0 mm	2.0 mm	500 mm	90°	200 mm	7.78 kg	113310501
○ 133.0 mm	2.0 mm	500 mm	45°	200 mm	5.20 kg	113310504
○ 133.0 mm	2.0 mm	800 mm	90°	200 mm	10.87 kg	113310802
○ 133.0 mm	2.0 mm	800 mm	45°	200 mm	6.75 kg	113310803
○ 133.0 mm	2.0 mm	1000 mm	90°	200 mm	12.93 kg	113310006
○ 133.0 mm	2.0 mm	1000 mm	45°	200 mm	7.78 kg	113310007
○ 133.0 mm	2.0 mm	1500 mm	90°	200 mm	18.08 kg	113310X10
○ 133.0 mm	2.0 mm	1500 mm	45°	200 mm	10.35 kg	113310X11

Stainless steel pipe bends Ø 133.0 x 3.0 mm

Outer pipe diameter	Wall thickness	Radius	Angle	Leg extension	Weight	Article number
○ 133.0 mm	3.0 mm	500 mm	90°	200 mm	11.58 kg	113310530
○ 133.0 mm	3.0 mm	500 mm	45°	200 mm	7.74 kg	113310531
○ 133.0 mm	3.0 mm	800 mm	90°	200 mm	16.19 kg	113310801
○ 133.0 mm	3.0 mm	800 mm	45°	200 mm	10.05 kg	113310804
○ 133.0 mm	3.0 mm	1000 mm	90°	200 mm	19.25 kg	113310002
○ 133.0 mm	3.0 mm	1000 mm	45°	200 mm	11.58 kg	113310004
○ 133.0 mm	3.0 mm	1500 mm	90°	200 mm	26.93 kg	113310X30
○ 133.0 mm	3.0 mm	1500 mm	45°	200 mm	15.42 kg	113310X31

Stainless steel pipe bends Ø 133.0 x 4.0 mm

Outer pipe diameter	Wall thickness	Radius	Angle	Leg extension	Weight	Article number
○ 133.0 mm	4.0 mm	800 mm	90°	200 mm	21.40 kg	113310840
○ 133.0 mm	4.0 mm	800 mm	45°	200 mm	13.29 kg	113310841
○ 133.0 mm	4.0 mm	1000 mm	90°	200 mm	25.46 kg	113310040
○ 133.0 mm	4.0 mm	1000 mm	45°	200 mm	15.32 kg	113310041
○ 133.0 mm	4.0 mm	1500 mm	90°	200 mm	35.61 kg	113310X45
○ 133.0 mm	4.0 mm	1500 mm	45°	200 mm	20.39 kg	113310X46

also in other angles available...

○ = no stock article | available at short notice

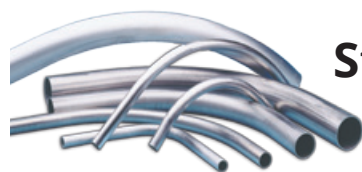

Stainless steel pipe bends

Material no. AISI 304 / 304 L

Stainless steel pipe bends Ø 139.7 x 2.0 mm						
Outer pipe diameter	Wall thickness	Radius	Angle	Leg extension	Weight	Article number
139.7 mm	2.0 mm	500 mm	90°	200 mm	8.17 kg	113910505
139.7 mm	2.0 mm	500 mm	45°	200 mm	5.46 kg	113910507
139.7 mm	2.0 mm	800 mm	90°	200 mm	11.41 kg	113910802
139.7 mm	2.0 mm	800 mm	45°	200 mm	7.09 kg	113910804
139.7 mm	2.0 mm	1000 mm	90°	200 mm	13.58 kg	113910001
139.7 mm	2.0 mm	1000 mm	45°	200 mm	8.17 kg	113910002
139.7 mm	2.0 mm	1200 mm	90°	200 mm	15.74 kg	113910X03 ○
139.7 mm	2.0 mm	1200 mm	45°	200 mm	9.25 kg	113910X05 ○
139.7 mm	2.0 mm	1500 mm	90°	200 mm	18.99 kg	113910X11 ○
139.7 mm	2.0 mm	1500 mm	45°	200 mm	10.87 kg	113910X12 ○

Stainless steel pipe bends Ø 139.7 x 2.6 mm						
Outer pipe diameter	Wall thickness	Radius	Angle	Leg extension	Weight	Article number
139.7 mm	2.6 mm	800 mm	90°	200 mm	14.78 kg	113910806 ○
139.7 mm	2.6 mm	800 mm	45°	200 mm	9.17 kg	113910807 ○
139.7 mm	2.6 mm	1000 mm	90°	200 mm	17.58 kg	113910003 ○
139.7 mm	2.6 mm	1000 mm	45°	200 mm	10.57 kg	113910008 ○
139.7 mm	2.6 mm	1200 mm	90°	200 mm	20.38 kg	113910X20 ○
139.7 mm	2.6 mm	1200 mm	45°	200 mm	11.97 kg	113910X21 ○
139.7 mm	2.6 mm	1500 mm	90°	200 mm	24.59 kg	113910X01 ○
139.7 mm	2.6 mm	1500 mm	45°	200 mm	14.08 kg	113910X06 ○

Stainless steel pipe bends Ø 139.7 x 3.0 mm						
Outer pipe diameter	Wall thickness	Radius	Angle	Leg extension	Weight	Article number
139.7 mm	3.0 mm	800 mm	90°	200 mm	17.01 kg	113910803 ○
139.7 mm	3.0 mm	800 mm	45°	200 mm	10.56 kg	113910805 ○
139.7 mm	3.0 mm	1000 mm	90°	200 mm	20.24 kg	113910009 ○
139.7 mm	3.0 mm	1000 mm	45°	200 mm	12.17 kg	113910010 ○
139.7 mm	3.0 mm	1200 mm	90°	200 mm	23.47 kg	113910X30 ○
139.7 mm	3.0 mm	1200 mm	45°	200 mm	13.79 kg	113910X31 ○
139.7 mm	3.0 mm	1500 mm	90°	200 mm	28.31 kg	113910X35 ○
139.7 mm	3.0 mm	1500 mm	45°	200 mm	16.21 kg	113910X36 ○

thicker-walled and in other materials also available...

no stock article | available at short notice = ○

Stainless steel pipe bends Ø 139.7 x 4.0 mm

Outer pipe diameter	Wall thickness	Radius	Angle	Leg extension	Weight	Article number
○ 139.7 mm	4.0 mm	800 mm	90°	200 mm	22.53 kg	113910801
○ 139.7 mm	4.0 mm	800 mm	45°	200 mm	13.99 kg	113910808
○ 139.7 mm	4.0 mm	1000 mm	90°	200 mm	26.80 kg	113910040
○ 139.7 mm	4.0 mm	1000 mm	45°	200 mm	16.12 kg	113910041
○ 139.7 mm	4.0 mm	1200 mm	90°	200 mm	31.08 kg	113910X40
○ 139.7 mm	4.0 mm	1200 mm	45°	200 mm	18.26 kg	113910X41
○ 139.7 mm	4.0 mm	1500 mm	90°	200 mm	37.48 kg	113910X45
○ 139.7 mm	4.0 mm	1500 mm	45°	200 mm	21.46 kg	113910X46

Stainless steel pipe bends Ø 154.0 x 2.0 mm

Outer pipe diameter	Wall thickness	Radius	Angle	Leg extension	Weight	Article number
154.0 mm	2.0 mm	1000 mm	90°	150 mm	14.24 kg	115410003
154.0 mm	2.0 mm	1000 mm	45°	150 mm	8.26 kg	115410004
154.0 mm	2.0 mm	500 mm	90°	200 mm	9.02 kg	115410501
154.0 mm	2.0 mm	500 mm	45°	200 mm	6.03 kg	115410503
154.0 mm	2.0 mm	800 mm	90°	200 mm	12.61 kg	115410801
154.0 mm	2.0 mm	800 mm	45°	200 mm	7.83 kg	115410803
○ 154.0 mm	2.0 mm	1200 mm	90°	200 mm	17.39 kg	115410X06
○ 154.0 mm	2.0 mm	1200 mm	45°	200 mm	10.22 kg	115410X09
○ 154.0 mm	2.0 mm	1500 mm	90°	200 mm	20.97 kg	115410X01
○ 154.0 mm	2.0 mm	1500 mm	45°	200 mm	12.01 kg	115410X10

Stainless steel pipe bends Ø 156.0 x 3.0 mm

Outer pipe diameter	Wall thickness	Radius	Angle	Leg extension	Weight	Article number
○ 156.0 mm	3.0 mm	500 mm	90°	200 mm	13.62 kg	115610501
○ 156.0 mm	3.0 mm	500 mm	45°	200 mm	9.11 kg	115610502
○ 156.0 mm	3.0 mm	800 mm	90°	200 mm	19.03 kg	115610801
○ 156.0 mm	3.0 mm	800 mm	45°	200 mm	11.82 kg	115610802
○ 156.0 mm	3.0 mm	1000 mm	90°	200 mm	22.64 kg	115610001
○ 156.0 mm	3.0 mm	1000 mm	45°	200 mm	13.62 kg	115610002
○ 156.0 mm	3.0 mm	1500 mm	90°	200 mm	31.67 kg	115610X01
○ 156.0 mm	3.0 mm	1500 mm	45°	200 mm	18.13 kg	115610X02

also in other angles available...

○ = no stock article | available at short notice



Stainless steel pipe bends

Material no. AISI 304 / 304 L

Stainless steel pipe bends Ø 159.0 x 2.0 mm

Outer pipe diameter	Wall thickness	Radius	Angle	Leg extension	Weight	Article number	
159.0 mm	2.0 mm	500 mm	90°	200 mm	9.32 kg	115910501	○
159.0 mm	2.0 mm	500 mm	45°	200 mm	6.23 kg	115910502	○
159.0 mm	2.0 mm	800 mm	90°	200 mm	13.02 kg	115910803	
159.0 mm	2.0 mm	800 mm	45°	200 mm	8.08 kg	115910804	
159.0 mm	2.0 mm	1000 mm	90°	200 mm	15.49 kg	115910002	○
159.0 mm	2.0 mm	1000 mm	45°	200 mm	9.32 kg	115910001	○
159.0 mm	2.0 mm	1200 mm	90°	200 mm	17.96 kg	115910X03	○
159.0 mm	2.0 mm	1200 mm	45°	200 mm	10.55 kg	115910X04	○
159.0 mm	2.0 mm	1500 mm	90°	200 mm	21.66 kg	115910X11	○
159.0 mm	2.0 mm	1500 mm	45°	200 mm	12.40 kg	115910X12	○

Stainless steel pipe bends Ø 159.0 x 3.0 mm

Outer pipe diameter	Wall thickness	Radius	Angle	Leg extension	Weight	Article number	
159.0 mm	3.0 mm	800 mm	90°	200 mm	19.42 kg	115910801	○
159.0 mm	3.0 mm	800 mm	45°	200 mm	12.05 kg	115910806	○
159.0 mm	3.0 mm	1000 mm	90°	200 mm	23.10 kg	115910003	○
159.0 mm	3.0 mm	1000 mm	45°	200 mm	13.89 kg	115910004	○
159.0 mm	3.0 mm	1200 mm	90°	200 mm	26.78 kg	115910X30	○
159.0 mm	3.0 mm	1200 mm	45°	200 mm	15.73 kg	115910X31	○
159.0 mm	3.0 mm	1500 mm	90°	200 mm	32.30 kg	115910X35	○
159.0 mm	3.0 mm	1500 mm	45°	200 mm	18.50 kg	115910X36	○

Stainless steel pipe bends Ø 168,3 x 2,0 mm

Outer pipe diameter	Wall thickness	Radius	Angle	Leg extension	Weight	Article number	
168.3 mm	2.0 mm	500 mm	90°	200 mm	9.86 kg	116810505	
168.3 mm	2.0 mm	500 mm	45°	200 mm	6.60 kg	116810510	
168.3 mm	2.0 mm	800 mm	90°	200 mm	13.78 kg	116810801	
168.3 mm	2.0 mm	800 mm	45°	200 mm	8.56 kg	116810802	
168.3 mm	2.0 mm	1000 mm	90°	200 mm	16.40 kg	116810001	
168.3 mm	2.0 mm	1000 mm	45°	200 mm	9.86 kg	116810002	
168.3 mm	2.0 mm	1200 mm	90°	200 mm	19.01 kg	116810X01	○
168.3 mm	2.0 mm	1200 mm	45°	200 mm	11.17 kg	116810X02	○
168.3 mm	2.0 mm	1500 mm	90°	200 mm	22.93 kg	116810X05	○
168.3 mm	2.0 mm	1500 mm	45°	200 mm	13.13 kg	116810X06	○

thicker-walled and in other materials also available...

no stock article | available at short notice = ○

Shot-blasted pipes and pipe bends

The company HS Umformtechnik supplies pipes and pipe bends made from cold-rolled material with a shot-blasted inner surface.

Production losses and machine downtimes because of clogged pipes can be very costly in the plastics industry: over long distances from the silos, day containers or octabins to further processing on extruders, injection moulding equipment or blown film lines, plastic granules are transported through pipe systems using vacuum or pressure.

In case of contact with a smooth inner wall, high product speeds, temperatures, pressures and friction pressure between the granules can lead to plastification.

The result is the formation of long **plastic threads, angel hair, or sauerkraut as this is called in technical jargon.**

The result is breakdown as well as the accumulation of impurities, going as far as the blockage of the entire pipeline.

This effect is prevented by properly roughening the interior pipe surfaces. The air flow through the pipeline creates an air cushion which prevents intensive contact with the granules as far as possible.



Blasting medium: cut wire shot made of stainless steel

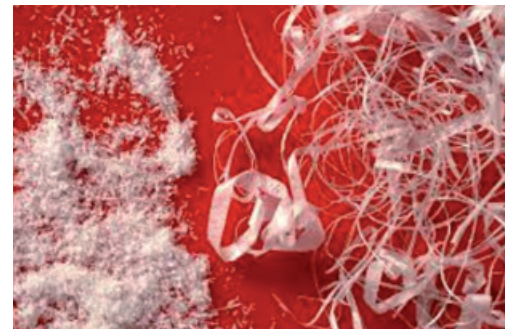

Plastic threads, angel hair

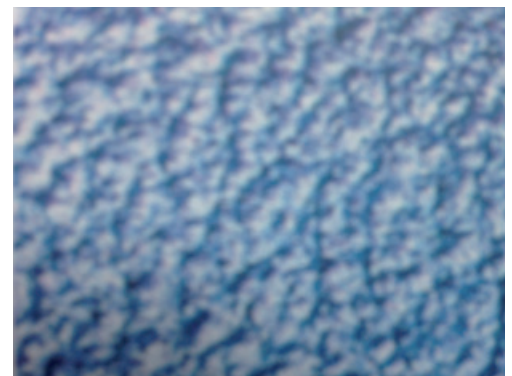

High-resolution photo of a shot-blasted inner surface

Pipes and pipe bends with shot-blasted inner surfaces available on request...

Available dimensions

Pipes Diameter from **38 mm to 206 mm**

Pipe bends Diameter from **38 mm to 206 mm**

Shot-blasted inside **40 – 70 µm**

Shot-blasted inside **40 – 70 µm**

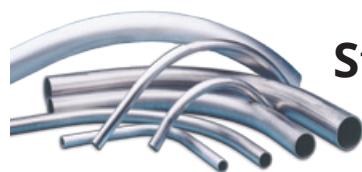

Stainless steel pipe bends

Material no. AISI 304 / 304 L

Stainless steel pipe bends Ø 168.3 x 2.6 mm						
Outer pipe diameter	Wall thickness	Radius	Angle	Leg extension	Weight	Article number
168.3 mm	2.6 mm	500 mm	90°	200 mm	12.80 kg	116810506 ○
168.3 mm	2.6 mm	500 mm	45°	200 mm	8.56 kg	116810509 ○
168.3 mm	2.6 mm	800 mm	90°	200 mm	17.89 kg	116810810 ○
168.3 mm	2.6 mm	800 mm	45°	200 mm	11.11 kg	116810811 ○
168.3 mm	2.6 mm	1000 mm	90°	200 mm	21.28 kg	116810005 ○
168.3 mm	2.6 mm	1000 mm	45°	200 mm	12.80 kg	116810008 ○
168.3 mm	2.6 mm	1200 mm	90°	200 mm	24.68 kg	116810X20 ○
168.3 mm	2.6 mm	1200 mm	45°	200 mm	14.50 kg	116810X21 ○
168.3 mm	2.6 mm	1500 mm	90°	200 mm	29.77 kg	116810X25 ○
168.3 mm	2.6 mm	1500 mm	45°	200 mm	17.04 kg	116810X26 ○

Stainless steel pipe bends Ø 168.3 x 3.0 mm						
Outer pipe diameter	Wall thickness	Radius	Angle	Leg extension	Weight	Article number
168.3 mm	3.0 mm	800 mm	90°	200 mm	20.58 kg	116810803 ○
168.3 mm	3.0 mm	800 mm	45°	200 mm	12.77 kg	116810805 ○
168.3 mm	3.0 mm	1000 mm	90°	200 mm	24.48 kg	116810010 ○
168.3 mm	3.0 mm	1000 mm	45°	200 mm	14.72 kg	116810011 ○
168.3 mm	3.0 mm	1200 mm	90°	200 mm	28.38 kg	116810X30 ○
168.3 mm	3.0 mm	1200 mm	45°	200 mm	16.67 kg	116810X31 ○
168.3 mm	3.0 mm	1500 mm	90°	200 mm	34.23 kg	116810X35 ○
168.3 mm	3.0 mm	1500 mm	45°	200 mm	19.60 kg	116810X36 ○

Stainless steel pipe bends Ø 168,3 x 4,0 mm						
Outer pipe diameter	Wall thickness	Radius	Angle	Leg extension	Weight	Article number
168.3 mm	4.0 mm	800 mm	90°	200 mm	27.17 kg	116810840 ○
168.3 mm	4.0 mm	800 mm	45°	200 mm	16.86 kg	116810841 ○
168.3 mm	4.0 mm	1000 mm	90°	200 mm	32.32 kg	116810040 ○
168.3 mm	4.0 mm	1000 mm	45°	200 mm	19.44 kg	116810041 ○
168.3 mm	4.0 mm	1200 mm	90°	200 mm	37.47 kg	116810X40 ○
168.3 mm	4.0 mm	1200 mm	45°	200 mm	22.02 kg	116810X41 ○
168.3 mm	4.0 mm	1500 mm	90°	200 mm	45.20 kg	116810X08 ○
168.3 mm	4.0 mm	1500 mm	45°	200 mm	25.88 kg	116810X07 ○

thicker-walled and in other materials also available...

no stock article | available at short notice = ○

Photo of the inside of the cutting robot

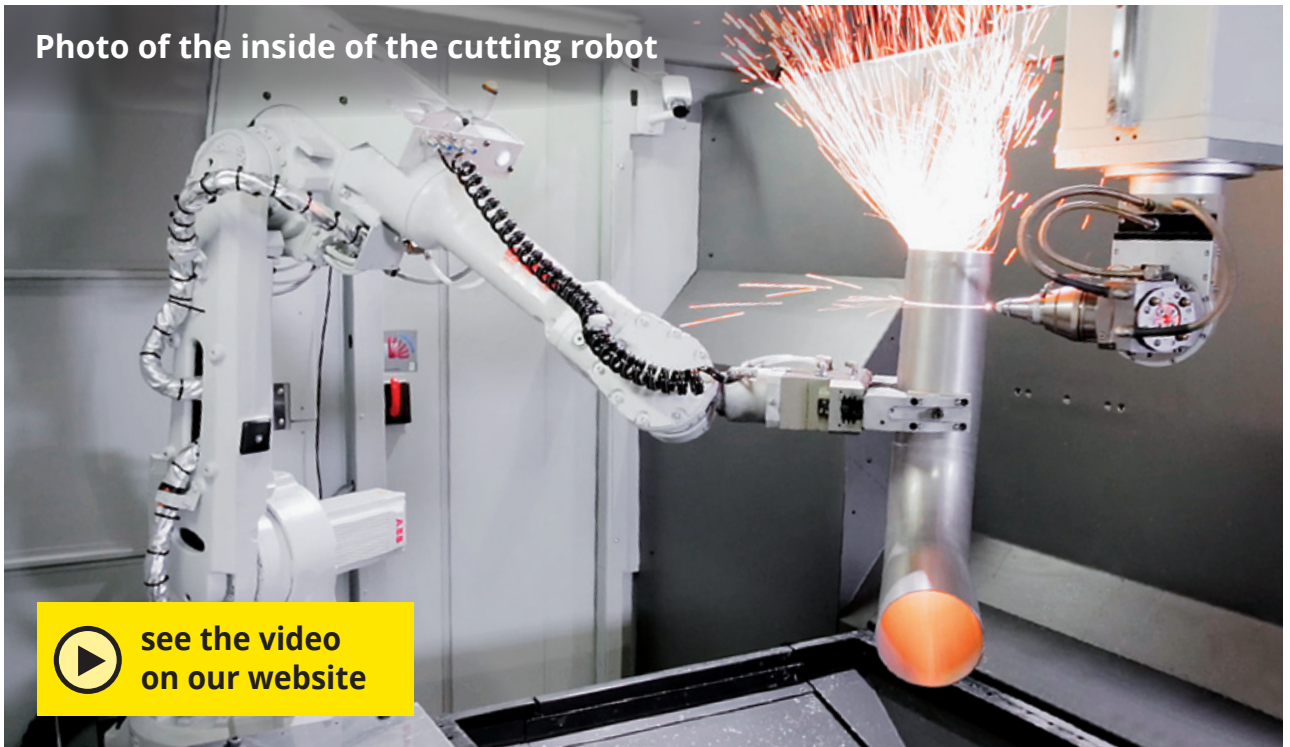

Stainless steel pipe bends Ø 204.0 x 2.0 mm

Outer pipe diameter	Wall thickness	Radius	Angle	Leg extension	Weight	Article number
○ 204.0 mm	2.0 mm	800 mm	90°	200 mm	16.77 kg	120410801
○ 204.0 mm	2.0 mm	800 mm	45°	200 mm	10.41 kg	120410802
○ 204.0 mm	2.0 mm	1000 mm	90°	200 mm	19.94 kg	120410001
○ 204.0 mm	2.0 mm	1000 mm	45°	200 mm	12.00 kg	120410002
○ 204.0 mm	2.0 mm	1200 mm	90°	200 mm	23.12 kg	120410X05
○ 204.0 mm	2.0 mm	1200 mm	45°	200 mm	13.59 kg	120410X06
○ 204.0 mm	2.0 mm	1500 mm	90°	200 mm	27.89 kg	120410X01
○ 204.0 mm	2.0 mm	1500 mm	45°	200 mm	15.97 kg	120410X02

Stainless steel pipe bends Ø 206.0 x 3.0 mm

Outer pipe diameter	Wall thickness	Radius	Angle	Leg extension	Weight	Article number
○ 206.0 mm	3.0 mm	1000 mm	90°	300 mm	33.10 kg	120610002
○ 206.0 mm	3.0 mm	1000 mm	45°	300 mm	21.13 kg	120610003
○ 206.0 mm	3.0 mm	1200 mm	90°	300 mm	37.90 kg	120610X01
○ 206.0 mm	3.0 mm	1200 mm	45°	300 mm	23.52 kg	120610X02
○ 206.0 mm	3.0 mm	1500 mm	90°	300 mm	45.08 kg	120610X11
○ 206.0 mm	3.0 mm	1500 mm	45°	300 mm	27.12 kg	120610X12

also in other angles available...

○ = no stock article | available at short notice



Stainless steel pipe bends D = 206.0 x 3.0 mm with radius 1500 mm

Aluminium pipe bends

for pneumatic conveying systems



- DIN EN 573-3, 755-1, /-2 /-9
- Alloy: AlMgSi 0,5 F22
- Outer pipe diameter: 38.0 – 100.0 x 2.0 mm
- Wall thickness: 1.5 mm / 2.0 mm or thicker
- Radius: 250 / 300 / 500 / 800 / 1.000 mm
- Absolutely wrinkle free, no start-up bulges
- Extremely low ovality
- Leg extension each side

... thicker-walled also available at short notice

Aluminium pipe bends Ø 38.0 x 1.5 mm

Outer pipe diameter	Wall thickness	Radius	Angle	Leg extension	Weight	Article number
○ 38.0 mm	1.5 mm	250 mm	90°	100 mm	0.29 kg	103850201
○ 38.0 mm	1.5 mm	250 mm	45°	100 mm	0.19 kg	103850202
○ 38.0 mm	1.5 mm	500 mm	90°	100 mm	0.48 kg	103850501
○ 38.0 mm	1.5 mm	500 mm	45°	100 mm	0.29 kg	103850502

Aluminium pipe bends Ø 40.0 x 1.5 mm

Outer pipe diameter	Wall thickness	Radius	Angle	Leg extension	Weight	Article number
40.0 mm	1.5 mm	250 mm	90°	100 mm	0.31 kg	104050201
40.0 mm	1.5 mm	250 mm	45°	100 mm	0.20 kg	104050202
40.0 mm	1.5 mm	500 mm	90°	200 mm	0.61 kg	104050503
40.0 mm	1.5 mm	500 mm	45°	200 mm	0.41 kg	104050504

Aluminium pipe bends Ø 45.0 x 1.5 mm

Outer pipe diameter	Wall thickness	Radius	Angle	Leg extension	Weight	Article number
○ 45.0 mm	1.5 mm	500 mm	90°	200 mm	0.69 kg	104550501
○ 45.0 mm	1.5 mm	500 mm	45°	200 mm	0.46 kg	104550502

also in other angles available...

○ = no stock article | available at short notice



Aluminium pipe bends

Aluminium pipe bends Ø 50.0 x 1.5 mm						
Outer pipe diameter	Wall thickness	Radius	Angle	Leg extension	Weight	Article number
50.0 mm	1.5 mm	75 mm	90°	100 mm	0.21 kg	105050002
50.0 mm	1.5 mm	75 mm	45°	100 mm	0.17 kg	105050003
50.0 mm	1.5 mm	250 mm	90°	100 mm	0.39 kg	105050203
50.0 mm	1.5 mm	250 mm	45°	100 mm	0.26 kg	105050204
50.0 mm	1.5 mm	500 mm	90°	200 mm	0.77 kg	105050501
50.0 mm	1.5 mm	500 mm	45°	200 mm	0.55 kg	105050503
50.0 mm	1.5 mm	800 mm	90°	200 mm	1.08 kg	105050803 ○
50.0 mm	1.5 mm	800 mm	45°	200 mm	0.67 kg	105050804 ○
50.0 mm	1.5 mm	1000 mm	90°	200 mm	1.28 kg	105050001 ○
50.0 mm	1.5 mm	1000 mm	45°	200 mm	0.77 kg	105050004 ○

Aluminium pipe bends Ø 60.3 x 1.5 mm						
Outer pipe diameter	Wall thickness	Radius	Angle	Leg extension	Weight	Article number
60.3 mm	1.5 mm	250 mm	90°	200 mm	0.62 kg	106050203 ○
60.3 mm	1.5 mm	250 mm	45°	200 mm	0.47 kg	106050204 ○
60.3 mm	1.5 mm	300 mm	90°	130 mm	0.58 kg	106050301
60.3 mm	1.5 mm	300 mm	45°	130 mm	0.39 kg	106050302
60.3 mm	1.5 mm	500 mm	90°	200 mm	0.93 kg	106050501 ○
60.3 mm	1.5 mm	500 mm	45°	200 mm	0.62 kg	106050504 ○

Aluminium pipe bends Ø 60.3 x 2.0 mm						
Outer pipe diameter	Wall thickness	Radius	Angle	Leg extension	Weight	Article number
60.3 mm	2.0 mm	160 mm	90°	100 mm	0.47 kg	106050105
60.3 mm	2.0 mm	160 mm	45°	100 mm	0.34 kg	106050106
60.3 mm	2.0 mm	250 mm	90°	200 mm	0.82 kg	106050201
60.3 mm	2.0 mm	250 mm	45°	200 mm	0.62 kg	106050202
60.3 mm	2.0 mm	500 mm	90°	200 mm	1.23 kg	106050502
60.3 mm	2.0 mm	500 mm	45°	200 mm	0.82 kg	106050503

no stock article | available at short notice = ○

Aluminium pipe bends Ø 65.0 x 2.0 mm

Outer pipe diameter	Wall thickness	Radius	Angle	Leg extension	Weight	Article number
65.0 mm	2.0 mm	250 mm	90°	200 mm	0.89 kg	106550201
○ 65.0 mm	2.0 mm	250 mm	45°	200 mm	0.67 kg	106550202
65.0 mm	2.0 mm	500 mm	90°	200 mm	1.34 kg	106550501
65.0 mm	2.0 mm	500 mm	45°	200 mm	0.89 kg	106550502
○ 65.0 mm	2.0 mm	800 mm	90°	200 mm	1.87 kg	106550801
○ 65.0 mm	2.0 mm	800 mm	45°	200 mm	1.16 kg	106550802
○ 65.0 mm	2.0 mm	1000 mm	90°	200 mm	2.22 kg	106550001
○ 65.0 mm	2.0 mm	1000 mm	45°	200 mm	1.34 kg	106550002

Aluminium pipe bends Ø 76.0 x 2.0 mm

Outer pipe diameter	Wall thickness	Radius	Angle	Leg extension	Weight	Article number
○ 76.0 mm	2.0 mm	250 mm	90°	200 mm	1.05 kg	107650201
○ 76.0 mm	2.0 mm	250 mm	45°	200 mm	0.79 kg	107650202
76.0 mm	2.0 mm	300 mm	45°	200 mm	0.84 kg	107650302
76.0 mm	2.0 mm	300 mm	90°	180 mm	1.10 kg	107650301
○ 76.0 mm	2.0 mm	500 mm	90°	200 mm	1.57 kg	107650502
○ 76.0 mm	2.0 mm	500 mm	45°	200 mm	1.05 kg	107650503

Aluminium pipe bends Ø 80.0 x 2.0 mm

Outer pipe diameter	Wall thickness	Radius	Angle	Leg extension	Weight	Article number
80.0 mm	2.0 mm	250 mm	90°	200 mm	1.11 kg	108050203
80.0 mm	2.0 mm	250 mm	45°	200 mm	0.83 kg	108050204
80.0 mm	2.0 mm	500 mm	90°	200 mm	1.65 kg	108050501
80.0 mm	2.0 mm	500 mm	45°	200 mm	1.11 kg	108050502
○ 80.0 mm	2.0 mm	800 mm	90°	200 mm	2.31 kg	108050801
○ 80.0 mm	2.0 mm	800 mm	45°	200 mm	1.44 kg	108050802

also in other angles available...

○ = no stock article | available at short notice



Aluminium pipe bends

Aluminium pipe bends Ø 90.0 x 3.0 mm						
Outer pipe diameter	Wall thickness	Radius	Angle	Leg extension	Weight	Article number
90.0 mm	3.0 mm	230 mm	90°	150 mm	1.46 kg	109070202
90.0 mm	3.0 mm	230 mm	45°	150 mm	1.12 kg	109070203

Aluminium pipe bends Ø 100.0 x 2.0 mm						
Outer pipe diameter	Wall thickness	Radius	Angle	Leg extension	Weight	Article number
100,0 mm	2,0 mm	250 mm	90°	200 mm	1,30 kg	110050201 ○
100,0 mm	2,0 mm	250 mm	45°	200 mm	0,98 kg	110050202 ○
100,0 mm	2,0 mm	500 mm	90°	200 mm	2,08 kg	110050501
100,0 mm	2,0 mm	500 mm	45°	200 mm	1,39 kg	110050502
100,0 mm	2,0 mm	800 mm	90°	200 mm	2,90 kg	110050801 ○
100,0 mm	2,0 mm	800 mm	45°	200 mm	1,80 kg	110050802 ○
100,0 mm	2,0 mm	1000 mm	90°	200 mm	3,46 kg	110050001 ○
100,0 mm	2,0 mm	1000 mm	45°	200 mm	2,08 kg	110050002 ○



no stock article | available at short notice = ○

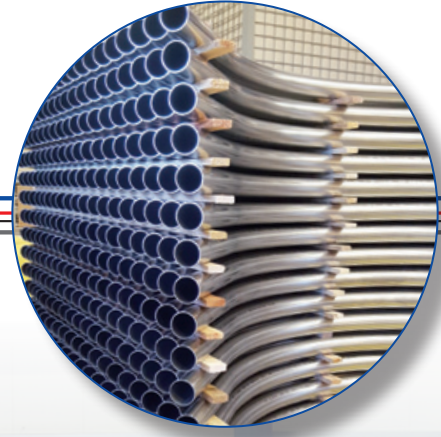
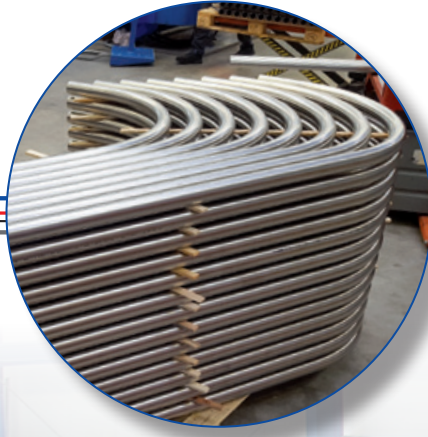

 see the video
on our website

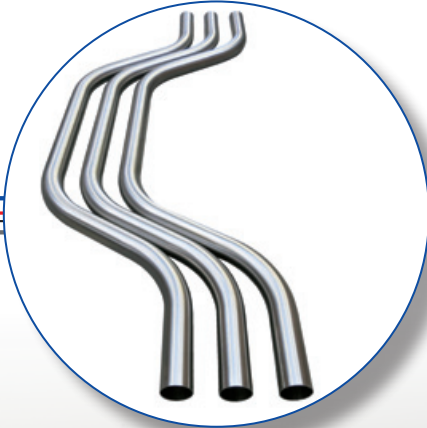
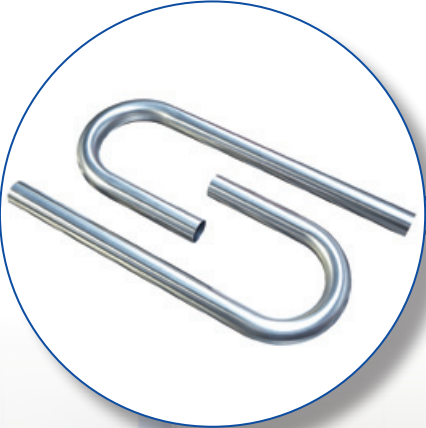

HVA NIRO® Stainless steel pipe bends

Material no. AISI 304 / AISI 304 L



Problems
with
wear and tear?
Why not ask us -
We have the solution for you!

Highly wear-resistant pipe bends

We can supply you with highly wear-resistant stainless steel pipe bends which have a service life 10 to 20 times longer than that of standard stainless steel pipe bends. This high degree of wear protection is required, for example, for conveying fibreglass-reinforced plastic granules or similarly abrasive media.

Complete coupling stations are also available in highly wear-resistant versions.

- Diameters from 38.0 to 168.3 mm
- Wall thickness from 1.5 mm to 2.0 mm
- Radius: 75 / 100 / 150 / 250 / 300 / 500 / 800 / 1000 mm
- For highly abrasive products
- Easy installation
- No stepped pipe couplings and no flange connections required

HVA NIRO® Stainless steel pipe bends Ø 38.0 x 1.5 mm

Outer pipe diameter	Wall thickness	Radius	Angle	Leg extension	Weight	Article number
○ 38.0 mm	1.5 mm	70 mm	90°	100 mm	0.42 kg	103819001
○ 38.0 mm	1.5 mm	70 mm	45°	100 mm	0.35 kg	103819002
○ 38.0 mm	1.5 mm	250 mm	90°	100 mm	0.81 kg	103819201
○ 38.0 mm	1.5 mm	250 mm	45°	100 mm	0.54 kg	103819202
○ 38.0 mm	1.5 mm	500 mm	90°	100 mm	1.35 kg	103819501
○ 38.0 mm	1.5 mm	500 mm	45°	100 mm	0.81 kg	103819502
○ 38.0 mm	1.5 mm	800 mm	90°	200 mm	2.27 kg	103819801
○ 38.0 mm	1.5 mm	800 mm	45°	200 mm	1.41 kg	103819802
○ 38.0 mm	1.5 mm	1000 mm	90°	200 mm	2.70 kg	103819004
○ 38.0 mm	1.5 mm	1000 mm	45°	200 mm	1.62 kg	103819014

also in other angles available...

○ = no stock article | available in 2 to 3 weeks



HVA NIRO® Stainless steel pipe bends

HVA NIRO® Stainless steel pipe bends Ø 40.0 x 1.5 mm						
Outer pipe diameter	Wall thickness	Radius	Angle	Leg extension	Weight	Article number
40.0 mm	1.5 mm	75 mm	90°	100 mm	0.46 kg	104019001
40.0 mm	1.5 mm	75 mm	45°	100 mm	0.33 kg	104019002
40.0 mm	1.5 mm	100 mm	90°	100 mm	0.52 kg	104019101 <input type="radio"/>
40.0 mm	1.5 mm	100 mm	45°	100 mm	0.40 kg	104019105 <input type="radio"/>
40.0 mm	1.5 mm	250 mm	90°	100 mm	0.86 kg	104019201
40.0 mm	1.5 mm	250 mm	45°	100 mm	0.57 kg	104019202
40.0 mm	1.5 mm	500 mm	90°	200 mm	1.72 kg	104019502
40.0 mm	1.5 mm	500 mm	45°	200 mm	1.15 kg	104019503
40.0 mm	1.5 mm	800 mm	90°	200 mm	2.40 kg	104019801 <input type="radio"/>
40.0 mm	1.5 mm	800 mm	45°	200 mm	1.49 kg	104019802 <input type="radio"/>
40.0 mm	1.5 mm	1000 mm	90°	200 mm	2.86 kg	104019003 <input type="radio"/>
40.0 mm	1.5 mm	1000 mm	45°	200 mm	1.72 kg	104019006 <input type="radio"/>

HVA NIRO® Stainless steel pipe bends Ø 45.0 x 1.5 mm						
Outer pipe diameter	Wall thickness	Radius	Angle	Leg extension	Weight	Article number
45.0 mm	1.5 mm	75 mm	90°	100 mm	0.52 kg	104519001 <input type="radio"/>
45.0 mm	1.5 mm	75 mm	45°	100 mm	0.42 kg	104519002 <input type="radio"/>
45.0 mm	1.5 mm	100 mm	90°	50 mm	0.42 kg	104519101
45.0 mm	1.5 mm	100 mm	45°	50 mm	0.29 kg	104519102
45.0 mm	1.5 mm	300 mm	90°	200 mm	1.42 kg	104519303
45.0 mm	1.5 mm	300 mm	45°	200 mm	1.04 kg	104519304 <input type="radio"/>
45.0 mm	1.5 mm	500 mm	90°	200 mm	1.93 kg	104519501
45.0 mm	1.5 mm	500 mm	45°	200 mm	1.29 kg	104519502 <input type="radio"/>

HVA NIRO® Stainless steel pipe bends Ø 50.0 x 1.5 mm						
Outer pipe diameter	Wall thickness	Radius	Angle	Leg extension	Weight	Article number
50.0 mm	1.5 mm	75 mm	90°	100 mm	0.58 kg	105019003
50.0 mm	1.5 mm	75 mm	45°	100 mm	0.47 kg	105019001
50.0 mm	1.5 mm	150 mm	90°	100 mm	0.79 kg	105019101 <input type="radio"/>
50.0 mm	1.5 mm	150 mm	45°	100 mm	0.58 kg	105019102 <input type="radio"/>
50.0 mm	1.5 mm	250 mm	90°	100 mm	1.08 kg	105019201
50.0 mm	1.5 mm	250 mm	45°	100 mm	0.72 kg	105019202

thicker-walled and in other materials also available...

no stock article | available in 2 to 3 weeks =

HVA NIRO® Stainless steel pipe bends Ø 50.0 x 1.5 mm

Outer pipe diameter	Wall thickness	Radius	Angle	Leg extension	Weight	Article number
50.0 mm	1.5 mm	500 mm	90°	200 mm	2.16 kg	105019502
50.0 mm	1.5 mm	500 mm	45°	200 mm	1.44 kg	105019503
○ 50.0 mm	1.5 mm	800 mm	90°	200 mm	3.02 kg	105019801
○ 50.0 mm	1.5 mm	800 mm	45°	200 mm	1.87 kg	105019802
○ 50.0 mm	1.5 mm	1000 mm	90°	200 mm	3.59 kg	105019009
○ 50.0 mm	1.5 mm	1000 mm	45°	200 mm	2.16 kg	105019006

HVA NIRO® Stainless steel pipe bends Ø 50.0 x 2.0 mm

Outer pipe diameter	Wall thickness	Radius	Angle	Leg extension	Weight	Article number
○ 50.0 mm	2.0 mm	75 mm	90°	100 mm	0.76 kg	105019004
○ 50.0 mm	2.0 mm	75 mm	45°	100 mm	0.62 kg	105019002
○ 50.0 mm	2.0 mm	150 mm	90°	100 mm	1.05 kg	105019107
○ 50.0 mm	2.0 mm	150 mm	45°	100 mm	0.76 kg	105019108
○ 50.0 mm	2.0 mm	250 mm	90°	200 mm	1.90 kg	105019208
○ 50.0 mm	2.0 mm	250 mm	45°	200 mm	1.43 kg	105019209
○ 50.0 mm	2.0 mm	500 mm	90°	200 mm	2.84 kg	105019519
○ 50.0 mm	2.0 mm	500 mm	45°	200 mm	1.90 kg	105019501
○ 50.0 mm	2.0 mm	800 mm	90°	200 mm	3.98 kg	105019805
○ 50.0 mm	2.0 mm	800 mm	45°	200 mm	2.47 kg	105019809
○ 50.0 mm	2.0 mm	1000 mm	90°	200 mm	4.73 kg	105019008
○ 50.0 mm	2.0 mm	1000 mm	45°	200 mm	2.84 kg	105019007

HVA NIRO® Stainless steel pipe bends Ø 54.0 x 2.0 mm

Outer pipe diameter	Wall thickness	Radius	Angle	Leg extension	Weight	Article number
○ 54.0 mm	2.0 mm	75 mm	90°	100 mm	0.83 kg	105419002
○ 54.0 mm	2.0 mm	75 mm	45°	100 mm	0.67 kg	105419003
○ 54.0 mm	2.0 mm	150 mm	90°	100 mm	1.13 kg	105419101
○ 54.0 mm	2.0 mm	150 mm	45°	100 mm	0.83 kg	105419102
○ 54.0 mm	2.0 mm	250 mm	90°	100 mm	1.54 kg	105419201
○ 54.0 mm	2.0 mm	250 mm	45°	100 mm	1.03 kg	105419202
54.0 mm	2.0 mm	500 mm	90°	200 mm	3.08 kg	105419501
54.0 mm	2.0 mm	500 mm	45°	200 mm	2.06 kg	105419502
○ 54.0 mm	2.0 mm	800 mm	90°	200 mm	4.31 kg	105419801
○ 54.0 mm	2.0 mm	800 mm	45°	200 mm	2.67 kg	105419802
○ 54.0 mm	2.0 mm	1000 mm	90°	200 mm	5.12 kg	105419005
○ 54.0 mm	2.0 mm	1000 mm	45°	200 mm	3.08 kg	105419006

also in other angles available...

○ = no stock article | available in 2 to 3 weeks



HVA NIRO® Stainless steel pipe bends

HVA NIRO® Stainless steel pipe bends Ø 60.3 x 1.5 mm						
Outer pipe diameter	Wall thickness	Radius	Angle	Leg extension	Weight	Article number
60.3 mm	1.5 mm	100 mm	90°	150 mm	1.01 kg	106019112
60.3 mm	1.5 mm	100 mm	45°	150 mm	0.84 kg	106019113 ○
60.3 mm	1.5 mm	115 mm	90°	150 mm	1.06 kg	106019110
60.3 mm	1.5 mm	115 mm	45°	150 mm	0.86 kg	106019111
60.3 mm	1.5 mm	250 mm	90°	200 mm	1.75 kg	106019207
60.3 mm	1.5 mm	250 mm	45°	200 mm	1.32 kg	106019208
60.3 mm	1.5 mm	300 mm	90°	200 mm	1.93 kg	106019306 ○
60.3 mm	1.5 mm	300 mm	45°	200 mm	1.40 kg	106019307 ○
60.3 mm	1.5 mm	500 mm	90°	200 mm	2.62 kg	106019510
60.3 mm	1.5 mm	500 mm	45°	200 mm	1.75 kg	106019511
60.3 mm	1.5 mm	800 mm	90°	150 mm	3.44 kg	106019810 ○
60.3 mm	1.5 mm	800 mm	45°	150 mm	2.05 kg	106019811 ○
60.3 mm	1.5 mm	1000 mm	90°	200 mm	4.36 kg	106019010 ○
60.3 mm	1.5 mm	1000 mm	45°	200 mm	2.62 kg	106019011 ○

HVA NIRO® Stainless steel pipe bends Ø 60.3 x 2.0 mm						
Outer pipe diameter	Wall thickness	Radius	Angle	Leg extension	Weight	Article number
60.3 mm	2.0 mm	100 mm	90°	100 mm	1.04 kg	106019106 ○
60.3 mm	2.0 mm	100 mm	45°	100 mm	0.81 kg	106019107 ○
60.3 mm	2.0 mm	115 mm	90°	150 mm	1.40 kg	106019101
60.3 mm	2.0 mm	115 mm	45°	150 mm	1.14 kg	106019102
60.3 mm	2.0 mm	250 mm	90°	200 mm	2.31 kg	106019201
60.3 mm	2.0 mm	250 mm	45°	200 mm	1.74 kg	106019202
60.3 mm	2.0 mm	300 mm	90°	100 mm	1.96 kg	106019308 ○
60.3 mm	2.0 mm	300 mm	45°	100 mm	1.27 kg	106019309 ○
60.3 mm	2.0 mm	500 mm	90°	200 mm	3.46 kg	106019501
60.3 mm	2.0 mm	500 mm	45°	200 mm	2.31 kg	106019502
60.3 mm	2.0 mm	800 mm	90°	200 mm	4.84 kg	106019801 ○
60.3 mm	2.0 mm	800 mm	45°	200 mm	3.00 kg	106019802 ○
60.3 mm	2.0 mm	1000 mm	90°	200 mm	5.75 kg	106019001 ○
60.3 mm	2.0 mm	1000 mm	45°	200 mm	3.46 kg	106019003 ○

thicker-walled and in other materials also available...

no stock article | available in 2 to 3 weeks = ○

HVA NIRO® Stainless steel pipe bends Ø 63.5 x 2.0 mm

Outer pipe diameter	Wall thickness	Radius	Angle	Leg extension	Weight	Article number
○ 63.5 mm	2.0 mm	160 mm	90°	150 mm	1.70 kg	106319101
○ 63.5 mm	2.0 mm	160 mm	45°	150 mm	1.31 kg	106319102
○ 63.5 mm	2.0 mm	500 mm	90°	200 mm	3.65 kg	106319501
○ 63.5 mm	2.0 mm	500 mm	45°	200 mm	2.44 kg	106319502
○ 63.5 mm	2.0 mm	800 mm	90°	200 mm	5.10 kg	106319801
○ 63.5 mm	2.0 mm	800 mm	45°	200 mm	3.17 kg	106319802
○ 63.5 mm	2.0 mm	1000 mm	90°	200 mm	6.07 kg	106319001
○ 63.5 mm	2.0 mm	1000 mm	45°	200 mm	3.65 kg	106319002

HVA NIRO® Stainless steel pipe bends Ø 65.0 x 1.5 mm

Outer pipe diameter	Wall thickness	Radius	Angle	Leg extension	Weight	Article number
○ 65.0 mm	1.5 mm	115 mm	90°	150 mm	1.13 kg	106519110
○ 65.0 mm	1.5 mm	115 mm	45°	150 mm	0.92 kg	106519111
○ 65.0 mm	1.5 mm	250 mm	90°	200 mm	1.87 kg	106519203
○ 65.0 mm	1.5 mm	250 mm	45°	200 mm	1.40 kg	106519207
○ 65.0 mm	1.5 mm	500 mm	90°	200 mm	2.79 kg	106519504
○ 65.0 mm	1.5 mm	500 mm	45°	200 mm	1.87 kg	106519505
○ 65.0 mm	1.5 mm	800 mm	90°	200 mm	3.90 kg	106519803
○ 65.0 mm	1.5 mm	800 mm	45°	200 mm	2.42 kg	106519807
○ 65.0 mm	1.5 mm	1000 mm	90°	200 mm	4.64 kg	106519002
○ 65.0 mm	1.5 mm	1000 mm	45°	200 mm	2.79 kg	106519003

HVA NIRO® Stainless steel pipe bends Ø 65.0 x 2.0 mm

Outer pipe diameter	Wall thickness	Radius	Angle	Leg extension	Weight	Article number
○ 65.0 mm	2.0 mm	115 mm	90°	150 mm	1.52 kg	106519101
○ 65.0 mm	2.0 mm	115 mm	45°	150 mm	1.23 kg	106519102
○ 65.0 mm	2.0 mm	250 mm	90°	200 mm	2.50 kg	106519201
○ 65.0 mm	2.0 mm	250 mm	45°	200 mm	1.88 kg	106519202
○ 65.0 mm	2.0 mm	500 mm	90°	200 mm	3.74 kg	106519501
○ 65.0 mm	2.0 mm	500 mm	45°	200 mm	2.50 kg	106519502
○ 65.0 mm	2.0 mm	800 mm	90°	200 mm	5.23 kg	106519801
○ 65.0 mm	2.0 mm	800 mm	45°	200 mm	3.24 kg	106519802
○ 65.0 mm	2.0 mm	1000 mm	90°	200 mm	6.22 kg	106519001
○ 65.0 mm	2.0 mm	1000 mm	45°	200 mm	3.74 kg	106519004

also in other angles available...

○ = no stock article | available in 2 to 3 weeks



HVA NIRO® Stainless steel pipe bends

HVA NIRO® Stainless steel pipe bends Ø 70.0 x 2.0 mm						
Outer pipe diameter	Wall thickness	Radius	Angle	Leg extension	Weight	Article number
70.0 mm	2.0 mm	95 mm	90°	180 mm	1.73 kg	107019003 ○
70.0 mm	2.0 mm	95 mm	45°	180 mm	1.48 kg	107019004 ○
70.0 mm	2.0 mm	250 mm	90°	200 mm	2.70 kg	107019201 ○
70.0 mm	2.0 mm	250 mm	45°	200 mm	2.03 kg	107019202 ○
70.0 mm	2.0 mm	400 mm	90°	200 mm	3.50 kg	107019401 ○
70.0 mm	2.0 mm	400 mm	45°	200 mm	2.43 kg	107019402 ○
70.0 mm	2.0 mm	500 mm	90°	200 mm	4.03 kg	107019501 ○
70.0 mm	2.0 mm	500 mm	45°	200 mm	2.70 kg	107019502 ○
70.0 mm	2.0 mm	800 mm	90°	200 mm	5.63 kg	107019801 ○
70.0 mm	2.0 mm	800 mm	45°	200 mm	3.50 kg	107019802 ○
70.0 mm	2.0 mm	1000 mm	90°	200 mm	6.70 kg	107019001 ○
70.0 mm	2.0 mm	1000 mm	45°	200 mm	4.03 kg	107019005 ○

HVA NIRO® Stainless steel pipe bends Ø 76.1 x 2.0 mm						
Outer pipe diameter	Wall thickness	Radius	Angle	Leg extension	Weight	Article number
76.1 mm	2.0 mm	180 mm	90°	200 mm	2.53 kg	107619101 ○
76.1 mm	2.0 mm	180 mm	45°	200 mm	2.00 kg	107619102 ○
76.1 mm	2.0 mm	250 mm	90°	200 mm	2.93 kg	107619201 ○
76.1 mm	2.0 mm	250 mm	45°	200 mm	2.21 kg	107619202 ○
76.1 mm	2.0 mm	500 mm	90°	200 mm	4.39 kg	107619501
76.1 mm	2.0 mm	500 mm	45°	200 mm	2.93 kg	107619502 ○
76.1 mm	2.0 mm	800 mm	90°	200 mm	6.13 kg	107619801 ○
76.1 mm	2.0 mm	800 mm	45°	200 mm	3.80 kg	107619802 ○
76.1 mm	2.0 mm	1000 mm	90°	200 mm	7.29 kg	107619001 ○
76.1 mm	2.0 mm	1000 mm	45°	200 mm	4.39 kg	107619002 ○

thicker-walled and in other materials also available...

no stock article | available in 2 to 3 weeks = ○

HVA NIRO® Stainless steel pipe bends Ø 80.0 x 1.5 mm

Outer pipe diameter	Wall thickness	Radius	Angle	Leg extension	Weight	Article number
○ 80.0 mm	1.5 mm	150 mm	90°	200 mm	1.88 kg	108019105
○ 80.0 mm	1.5 mm	150 mm	45°	200 mm	1.53 kg	108019106
○ 80.0 mm	1.5 mm	250 mm	90°	200 mm	2.34 kg	108019203
○ 80.0 mm	1.5 mm	250 mm	45°	200 mm	1.76 kg	108019204
○ 80.0 mm	1.5 mm	500 mm	90°	200 mm	3.50 kg	108019503
○ 80.0 mm	1.5 mm	500 mm	45°	200 mm	2.34 kg	108019510
○ 80.0 mm	1.5 mm	800 mm	90°	200 mm	4.89 kg	108019808
○ 80.0 mm	1.5 mm	800 mm	45°	200 mm	3.03 kg	108019807
○ 80.0 mm	1.5 mm	1000 mm	90°	200 mm	5.81 kg	108019005
○ 80.0 mm	1.5 mm	1000 mm	45°	200 mm	3.50 kg	108019006

HVA NIRO® Stainless steel pipe bends Ø 80.0 x 2.0 mm

Outer pipe diameter	Wall thickness	Radius	Angle	Leg extension	Weight	Article number
○ 80.0 mm	2.0 mm	150 mm	90°	200 mm	2.49 kg	108019101
○ 80.0 mm	2.0 mm	150 mm	45°	200 mm	2.02 kg	108019102
○ 80.0 mm	2.0 mm	250 mm	90°	200 mm	3.10 kg	108019201
○ 80.0 mm	2.0 mm	250 mm	45°	200 mm	2.33 kg	108019202
○ 80.0 mm	2.0 mm	500 mm	90°	200 mm	4.63 kg	108019501
○ 80.0 mm	2.0 mm	500 mm	45°	200 mm	3.10 kg	108019502
○ 80.0 mm	2.0 mm	800 mm	90°	200 mm	6.48 kg	108019801
○ 80.0 mm	2.0 mm	800 mm	45°	200 mm	4.02 kg	108019802
○ 80.0 mm	2.0 mm	1000 mm	90°	200 mm	7.71 kg	108019001
○ 80.0 mm	2.0 mm	1000 mm	45°	200 mm	4.63 kg	108019002

HVA NIRO® Stainless steel pipe bends Ø 84.0 x 2.0 mm

Outer pipe diameter	Wall thickness	Radius	Angle	Leg extension	Weight	Article number
○ 84.0 mm	2.0 mm	150 mm	90°	200 mm	2.61 kg	108419101
○ 84.0 mm	2.0 mm	150 mm	45°	200 mm	2.13 kg	108419102
○ 84.0 mm	2.0 mm	250 mm	90°	200 mm	3.26 kg	108419201
○ 84.0 mm	2.0 mm	250 mm	45°	200 mm	2.45 kg	108419202
○ 84.0 mm	2.0 mm	500 mm	90°	200 mm	4.87 kg	108419501
○ 84.0 mm	2.0 mm	500 mm	45°	200 mm	3.26 kg	108419502
○ 84.0 mm	2.0 mm	800 mm	90°	200 mm	6.81 kg	108419801
○ 84.0 mm	2.0 mm	800 mm	45°	200 mm	4.23 kg	108419802
○ 84.0 mm	2.0 mm	1000 mm	90°	200 mm	8.10 kg	108419001
○ 84.0 mm	2.0 mm	1000 mm	45°	200 mm	4.87 kg	108419002

also in other angles available...

○ = no stock article | available in 2 to 3 weeks



HVA NIRO® Stainless steel pipe bends

HVA NIRO® Stainless steel pipe bends Ø 85.0 x 2.0 mm

Outer pipe diameter	Wall thickness	Radius	Angle	Leg extension	Weight	Article number	
85.0 mm	2.0 mm	500 mm	90°	200 mm	4.93 kg	108519501	○
85.0 mm	2.0 mm	500 mm	45°	200 mm	3.30 kg	108519502	○
85.0 mm	2.0 mm	800 mm	90°	200 mm	6.89 kg	108519801	○
85.0 mm	2.0 mm	800 mm	45°	200 mm	4.28 kg	108519802	○
85.0 mm	2.0 mm	1000 mm	90°	200 mm	8.20 kg	108519001	○
85.0 mm	2.0 mm	1000 mm	45°	200 mm	4.93 kg	108519004	○

HVA NIRO® Stainless steel pipe bends Ø 88.9 x 2.0 mm

Outer pipe diameter	Wall thickness	Radius	Angle	Leg extension	Weight	Article number	
88.9 mm	2.0 mm	150 mm	90°	200 mm	2.76 kg	108819101	○
88.9 mm	2.0 mm	150 mm	45°	200 mm	2.25 kg	108819102	○
88.9 mm	2.0 mm	250 mm	90°	200 mm	3.45 kg	108819201	○
88.9 mm	2.0 mm	250 mm	45°	200 mm	2.59 kg	108819202	○
88.9 mm	2.0 mm	500 mm	90°	200 mm	5.16 kg	108819501	
88.9 mm	2.0 mm	500 mm	45°	200 mm	3.45 kg	108819502	
88.9 mm	2.0 mm	800 mm	90°	200 mm	7.21 kg	108819801	○
88.9 mm	2.0 mm	800 mm	45°	200 mm	4.47 kg	108819802	○
88.9 mm	2.0 mm	1000 mm	90°	200 mm	8.57 kg	108819003	○
88.9 mm	2.0 mm	1000 mm	45°	200 mm	5.16 kg	108819013	○

HVA NIRO® Stainless steel pipe bends Ø 100.0 x 1.5 mm

Outer pipe diameter	Wall thickness	Radius	Angle	Leg extension	Weight	Article number	
100.0 mm	1.5 mm	145 mm	90°	200 mm	2.32 kg	110019102	○
100.0 mm	1.5 mm	145 mm	45°	200 mm	1.90 kg	110019103	○
100.0 mm	1.5 mm	500 mm	90°	200 mm	4.39 kg	110019501	○
100.0 mm	1.5 mm	500 mm	45°	200 mm	2.93 kg	110019502	○
100.0 mm	1.5 mm	800 mm	90°	200 mm	6.13 kg	110019801	○
100.0 mm	1.5 mm	800 mm	45°	200 mm	3.80 kg	110019803	○
100.0 mm	1.5 mm	1000 mm	90°	200 mm	7.29 kg	110019002	○
100.0 mm	1.5 mm	1000 mm	45°	200 mm	4.39 kg	110019003	○

thicker-walled and in other materials also available...

no stock article | available in 2 to 3 weeks = ○

HVA NIRO® Stainless steel pipe bends Ø 101.6 x 2.0 mm

Outer pipe diameter	Wall thickness	Radius	Angle	Leg extension	Weight	Article number
○ 101.6 mm	2.0 mm	150 mm	90°	200 mm	3.17 kg	110119104
○ 101.6 mm	2.0 mm	150 mm	45°	200 mm	2.58 kg	110119105
○ 101.6 mm	2.0 mm	500 mm	90°	200 mm	5.90 kg	110119501
○ 101.6 mm	2.0 mm	500 mm	45°	200 mm	3.95 kg	110119502
○ 101.6 mm	2.0 mm	800 mm	90°	200 mm	8.25 kg	110119801
○ 101.6 mm	2.0 mm	800 mm	45°	200 mm	5.12 kg	110119802
○ 101.6 mm	2.0 mm	1000 mm	90°	200 mm	9.81 kg	110119001
○ 101.6 mm	2.0 mm	1000 mm	45°	200 mm	5.90 kg	110119002

HVA NIRO® Stainless steel pipe bends Ø 104.0 x 2.0 mm

Outer pipe diameter	Wall thickness	Radius	Angle	Leg extension	Weight	Article number
○ 104.0 mm	2.0 mm	150 mm	90°	250 mm	3.76 kg	110419101
○ 104.0 mm	2.0 mm	150 mm	45°	250 mm	3.16 kg	110419102
○ 104.0 mm	2.0 mm	500 mm	90°	200 mm	6.06 kg	110419502
○ 104.0 mm	2.0 mm	500 mm	45°	200 mm	4.05 kg	110419503
○ 104.0 mm	2.0 mm	800 mm	90°	200 mm	8.47 kg	110419801
○ 104.0 mm	2.0 mm	800 mm	45°	200 mm	5.25 kg	110419802
○ 104.0 mm	2.0 mm	1000 mm	90°	200 mm	10.07 kg	110419001
○ 104.0 mm	2.0 mm	1000 mm	45°	200 mm	6.06 kg	110419002

HVA NIRO® Stainless steel pipe bends Ø 108.0 x 2.0 mm

Outer pipe diameter	Wall thickness	Radius	Angle	Leg extension	Weight	Article number
○ 108.0 mm	2.0 mm	500 mm	90°	200 mm	6.29 kg	110819502
○ 108.0 mm	2.0 mm	500 mm	45°	200 mm	4.21 kg	110819504
○ 108.0 mm	2.0 mm	800 mm	90°	200 mm	8.80 kg	110819801
○ 108.0 mm	2.0 mm	800 mm	45°	200 mm	5.46 kg	110819802
○ 108.0 mm	2.0 mm	1000 mm	90°	200 mm	10.46 kg	110819011
○ 108.0 mm	2.0 mm	1000 mm	45°	200 mm	6.29 kg	110819012

also in other angles available...

○ = no stock article | available in 2 to 3 weeks



HVA NIRO® Stainless steel pipe bends

HVA NIRO® Stainless steel pipe bends Ø 114.3 x 2.0 mm

Outer pipe diameter	Wall thickness	Radius	Angle	Leg extension	Weight	Article number	
114.3 mm	2.0 mm	150 mm	90°	200 mm	3.57 kg	111419101	○
114.3 mm	2.0 mm	150 mm	45°	200 mm	2.91 kg	111419102	○
114.3 mm	2.0 mm	500 mm	90°	200 mm	6.66 kg	111419501	○
114.3 mm	2.0 mm	500 mm	45°	200 mm	4.45 kg	111419502	○
114.3 mm	2.0 mm	800 mm	90°	200 mm	9.31 kg	111419802	○
114.3 mm	2.0 mm	800 mm	45°	200 mm	5.78 kg	111419803	○
114.3 mm	2.0 mm	1000 mm	90°	200 mm	11.08 kg	111419001	○
114.3 mm	2.0 mm	1000 mm	45°	200 mm	6.66 kg	111419002	○

HVA NIRO® Stainless steel pipe bends Ø 129.0 x 2.0 mm

Outer pipe diameter	Wall thickness	Radius	Angle	Leg extension	Weight	Article number	
129.0 mm	2.0 mm	500 mm	90°	200 mm	7.54 kg	112919505	○
129.0 mm	2.0 mm	500 mm	45°	200 mm	5.04 kg	112919506	○
129.0 mm	2.0 mm	800 mm	90°	200 mm	10.54 kg	112919803	○
129.0 mm	2.0 mm	800 mm	45°	200 mm	6.54 kg	112919804	○
129.0 mm	2.0 mm	1000 mm	90°	200 mm	12.53 kg	112919002	○
129.0 mm	2.0 mm	1000 mm	45°	200 mm	7.54 kg	112919003	○

HVA NIRO® Stainless steel pipe bends Ø 139.7 x 2.0 mm

Outer pipe diameter	Wall thickness	Radius	Angle	Leg extension	Weight	Article number	
139.7 mm	2.0 mm	500 mm	90°	200 mm	8.17 kg	113919505	○
139.7 mm	2.0 mm	500 mm	45°	200 mm	5.46 kg	113919507	○
139.7 mm	2.0 mm	800 mm	90°	200 mm	11.41 kg	113919802	○
139.7 mm	2.0 mm	800 mm	45°	200 mm	7.09 kg	113919804	○
139.7 mm	2.0 mm	1000 mm	90°	200 mm	13.58 kg	113919001	○
139.7 mm	2.0 mm	1000 mm	45°	200 mm	8.17 kg	113919002	○

thicker-walled and in other materials also available...

no stock article | available in 2 to 3 weeks = ○

Glass pipe bends highly wear-resistant

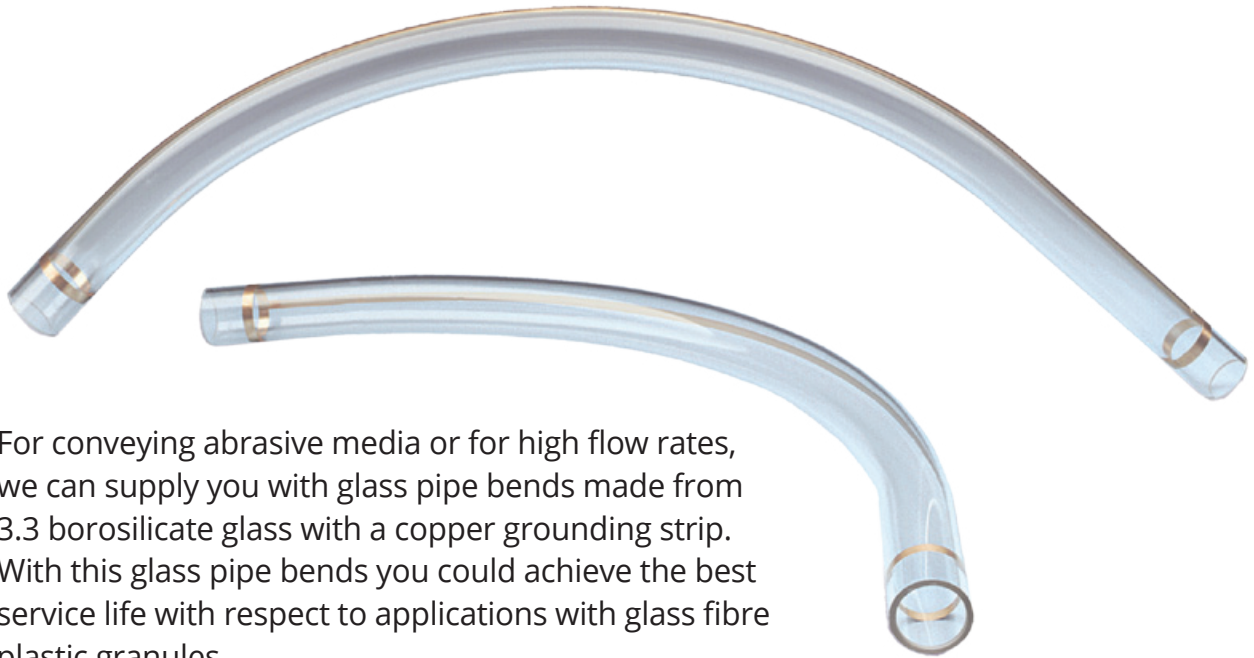

For conveying abrasive media or for high flow rates, we can supply you with glass pipe bends made from 3.3 borosilicate glass with a copper grounding strip. With this glass pipe bends you could achieve the best service life with respect to applications with glass fibre plastic granules.

Pipe couplings for different diameters Connections from glass to glass

Diameter	Length	Article number
47.0 mm	100 mm	404735H03
56.0 mm	100 mm	405635H03
66.0 mm	100 mm	406635H03

Pipe couplings for different pipe diameters for connection of glass pipe bends with stainless steel pipe

Pipe coupling DVK 6 sliced model
with black natural rubber gasket

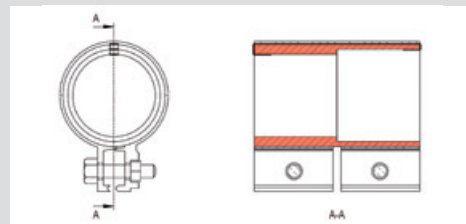

Pipe couplings for different diameters

Diameter	Length	Article number
47.0/40.0 mm	100 mm	404735HR3
48.0/45.0 mm	100 mm	404835HR9
56.0/50.0 mm	100 mm	405635HR3
66.0/60.0 mm	100 mm	406635HR3

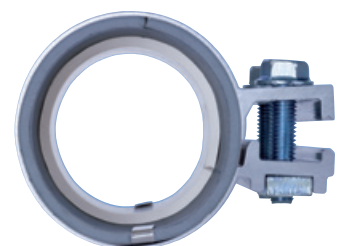

Without casing				Glass pipe bend Ø 47.0 x 5.0 mm		
Outer pipe diameter	Wall thickness	Radius	Angle	Leg extension	Weight	Article number
47.0 mm	5.0 mm	75 mm	45°	100/150	0.48 kg	1047GL004
47.0 mm	5.0 mm	250 mm	90°	200 mm	1.17 kg	1047GL201
47.0 mm	5.0 mm	250 mm	45°	200 mm	0.92 kg	1047GL202
47.0 mm	5.0 mm	500 mm	90°	200 mm	1.76 kg	1047GL501
47.0 mm	5.0 mm	500 mm	45°	200 mm	1.17 kg	1047GL502

Without casing				Glass pipe bend Ø 56.0 x 5.0 mm		
Outer pipe diameter	Wall thickness	Radius	Angle	Leg extension	Weight	Article number
56.0 mm	5.0 mm	75 mm	45°	100/150	0.56 kg	1056GL002
56,0 mm	5,0 mm	250 mm	90°	100 mm	1,45 kg	1056GL205
56,0 mm	5,0 mm	250 mm	90°	200 mm	1,45 kg	1056GL203
56,0 mm	5,0 mm	250 mm	45°	100 mm	1,12 kg	1056GL206
56,0 mm	5,0 mm	250 mm	45°	200 mm	1,07 kg	1056GL204
56,0 mm	5,0 mm	500 mm	90°	100 mm	1,83 kg	1056GL506
56,0 mm	5,0 mm	500 mm	90°	200 mm	2,13 kg	1056GL501
56,0 mm	5,0 mm	500 mm	45°	100 mm	1,10 kg	1056GL507
56,0 mm	5,0 mm	500 mm	45°	200 mm	1,43 kg	1056GL502

Without casing				Glass pipe bend Ø 66.0 x 5.0 mm		
Outer pipe diameter	Wall thickness	Radius	Angle	Leg extension	Weight	Article number
66.0 mm	5.0 mm	115 mm	45°	100/150	0.70 kg	1066GL103
66.0 mm	5.0 mm	250 mm	90°	200 mm	1.60 kg	1066GL201
66.0 mm	5.0 mm	250 mm	45°	200 mm	1.32 kg	1066GL202
66.0 mm	5.0 mm	500 mm	90°	200 mm	2.55 kg	1066GL502
66.0 mm	5.0 mm	500 mm	45°	200 mm	1.70 kg	1066GL503

Glass pipe bends encased in plastic

Encased in plastic



New | on request!

Broken encased in plastic

 see the video on our website

Highly wear-resistant DWR double-skin pipe bend

Material: Stainless steel

Put an end to wear!

Our solution: DWR pipe bends

In pneumatic conveying systems, conveying abrasive products - in particular at high conveying speeds - leads to abrasion and thus to wear in the pipe bends.

In the double-skin version of our highly wear-resistant **DWR** stainless steel pipe bend, the pipe bend is encased in a second pipe bend, creating a double-walled chamber. This acts as a **protective shield**.

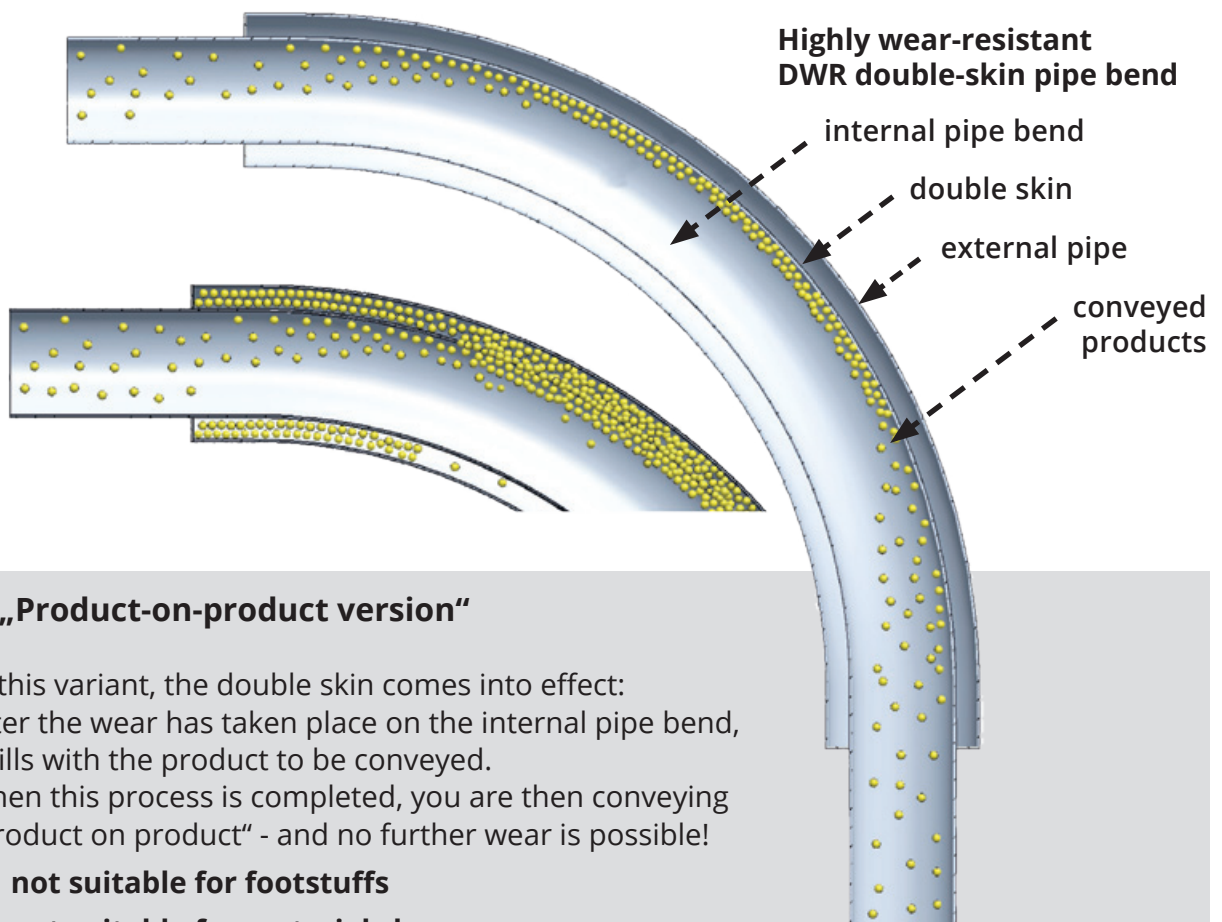

1. „Product-on-product version“

In this variant, the double skin comes into effect: After the wear has taken place on the internal pipe bend, it fills with the product to be conveyed. When this process is completed, you are then conveying „product on product“ - and no further wear is possible!

- **not suitable for footstuffs**
- **not suitable for material changes**

Production of every other angles is possible at short notice.

DWR Double-skin pipe bend



optionally available:

Double skin lined with concrete

- extremely hard special concrete
- long service life
- ceramic-like properties

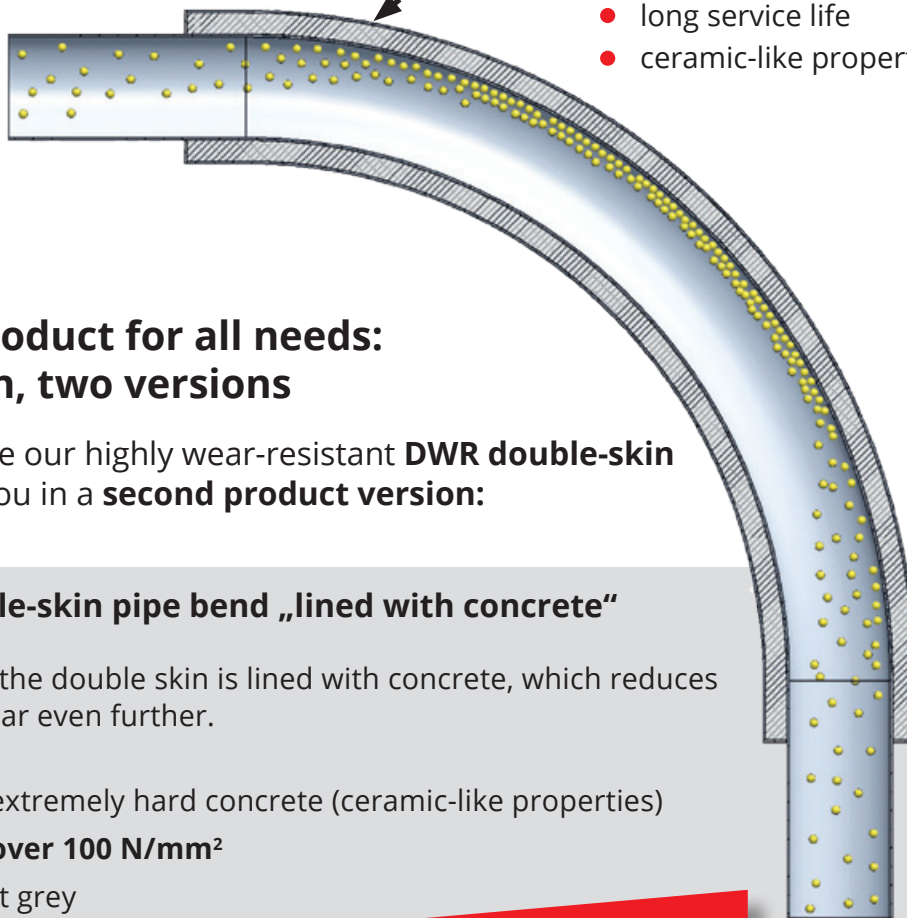

The right product for all needs: one solution, two versions

We also produce our highly wear-resistant **DWR double-skin** pipe bend for you in a **second product version**:

2. DWR double-skin pipe bend „lined with concrete“

In this variant, the double skin is lined with concrete, which reduces the signs of wear even further.

- lined with extremely hard concrete (ceramic-like properties)
- **strength: over 100 N/mm²**
- colour: light grey
- **not suitable for foodstuffs**

**available
at request**

Production of every other angles is possible at short notice.

Pneumatic tube pipe bends

unannealed and annealed stainless steel pipe bends for pneumatic tube systems



see the video
on our website

- no more deformation of roundness when cutting of bends on site
- easier extension-pipe/tiered pipe bend construction
- appealing visually pickled surface

All of our pipes and pipe bends (both unannealed and annealed) are made of the following material:

- stainless steel pipe, material no. AISI 304 (1.4301)
- longitudinal seam welded pipes
- **hot rolled & cold rolled coils, unannealed, with or without pickling (W1)**
- Material: **Ilta Inox and/or Marcegaglia**

We would be pleased to send you a sample of our unannealed / annealed pipe bends as a demonstration of our capabilities!

Please consult our besides standing tool and stock list for further diameter options for pneumatic tube applications.

**Annealed pipe bends for offset/
multifloor pipeline construction
- on request**

Production of every other angles is possible at short notice.

Stainless steel pipe bends for pneumatic tube systems

Tool list

for our CNC-mandrel machines

... You will find article numbers in the pipe bend section

Stainless steel pneumatic tube pipe bends – at short notice

Diameter in mm	Radius in mm				
	500	800	1000	1200	1500
80.0 x 2.0	●	●	●	●	●
80.0 x 2.5	●	●	●	●	●
100.0 x 1.5	●	●	●	●	●
104.0 x 2.0	●	●	●	●	●
108.0 x 2.0	●	●	●	●	●
110.0 x 2.0	●	●	●	●	●
129.0 x 2.0	●	●	●	●	●
154.0 x 2.0	●	●	●	●	●
159.0 x 2.0	●	●	●	●	●
204.0 x 2.0	●	●	●	●	●



Production of every other angles is possible at short notice.

Stainless steel pipes

for pneumatic conveying systems



**shot-blasted and electronically polished
pipes and pipe bends on request**

Our stainless steel pipes are characterised by the following properties:

- Material nos. AISI 304 / AISI 321 or AISI 316 L / AISI 316 Ti, other materials on request
- DIN 11 850 / DIN EN 10 357 and EN 10 217-7 (DIN 17 457)
- Outer pipe diameters: from 38.0 - 206.0 mm
- Wall thicknesses: 1.5 mm / 2.0 mm or thicker
- Length: 6 metres
- Pipe ends deburred
- Absolutely smooth welding seams
- Delivery quantities picked according to customer requirements
- Good protective packaging for transportation



Stainless steel pipes

Material no. AISI 304 / 304 L

Stainless steel pipes			
Outer pipe diameter	Wall thickness	Weight/ m	Article number
38.0 mm	1.5 mm	1.37 kg	903810001
40.0 mm	1.5 mm	1.45 kg	904010001
40.0 mm	2.0 mm	1.90 kg	904010002
42.4 mm	2.0 mm	2.02 kg	904210001
45.0 mm	1.5 mm	1.63 kg	904510002
48.3 mm	2.0 mm	2.31 kg	904810003
50.0 mm	1.5 mm	1.82 kg	905010001
50.0 mm	2.0 mm	2.40 kg	905010004
50.8 mm	1.5 mm	1.86 kg	905110001
54.0 mm	2.0 mm	2.60 kg	905410002
60.3 mm	1.5 mm	2.21 kg	906010002
60.3 mm	2.0 mm	2.92 kg	906010001
63.5 mm	1.5 mm	2.33 kg	906310002
63.5 mm	2.0 mm	3.08 kg	906310001
65.0 mm	1.5 mm	2.40 kg	906510003
65.0 mm	2.0 mm	3.16 kg	906510001
70.0 mm	2.0 mm	3.40 kg	907010001
76.1 mm	2.0 mm	3.70 kg	907610001
80.0 mm	1.5 mm	2.95 kg	908010005
80.0 mm	2.0 mm	3.91 kg	908010001

Stainless steel pipes			
Outer pipe diameter	Wall thickness	Weight/ m	Article number
84.0 mm	2.0 mm	4.11 kg	908410001
85.0 mm	2.0 mm	4.16 kg	908510001
88.9 mm	2.0 mm	4.35 kg	908810001
100.0 mm	1.5 mm	3.70 kg	910010001
101.6 mm	2.0 mm	4.98 kg	910110001
104.0 mm	2.0 mm	5.11 kg	910410001
108.0 mm	2.0 mm	5.31 kg	910810003
110.0 mm	2.0 mm	5.41 kg	911010001
114.3 mm	2.0 mm	5.62 kg	911410001
125.0 mm	2.0 mm	6.16 kg	912510001
128.0 mm	1.5 mm	4.75 kg	912810001
129.0 mm	2.0 mm	6.36 kg	912910001
133.0 mm	2.0 mm	6.56 kg	913310003
139.7 mm	2.0 mm	6.89 kg	913910001
154.0 mm	2.0 mm	7.61 kg	915410001
156.0 mm	3.0 mm	11.49 kg	915610001
159.0 mm	2.0 mm	7.68 kg	915910007
168.3 mm	2.0 mm	8.32 kg	916810003
204.0 mm	2.0 mm	10.12 kg	920410001

Dust covers

to protect the inside of the pipes from dust and dirt



on request

Aluminium pipes

for pneumatic conveying systems



Our aluminium pipes offer the following characteristics:

- Alloy: AlMgSi 0,5 F22 (6060 T66), F18 und F16
- DIN EN 573-3, 755-1/-2/-9 and DIN 11 850 / DIN EN 10 357
- Outer pipe diameter: 38.0 – 100.0 mm
- Wall thickness: 1.5 mm / 2.0 mm or thicker
- Other dimensions - on request
- Length: 6 mtr.

Aluminium-Pipes			
Outer pipe diameter	Wall thickness	Weight/ m	Article number
38.0 mm	1.5 mm	0.48 kg	903850002
40.0 mm	1.5 mm	0.53 kg	904050001
45.0 mm	1.5 mm	0.58 kg	904550001
50.0 mm	1.5 mm	0.65 kg	905050001
50.0 mm	2.0 mm	0.80 kg	905050002
54.0 mm	2.0 mm	0.87 kg	905450001
60.3 mm	1.5 mm	0.75 kg	906050008
60.3 mm	2.0 mm	0.89 kg	906050010

Aluminium-Pipes			
Outer pipe diameter	Wall thickness	Weight/ m	Article number
65.0 mm	2.0 mm	1.12 kg	906550003
70.0 mm	2.0 mm	1.14 kg	907050001
76.0 mm	2.0 mm	1.30 kg	907650003
80.0 mm	2.0 mm	1.31 kg	908050002
84.0 mm	2.0 mm	1.41 kg	908450001
89.0 mm	2.0 mm	1.48 kg	908950001
90.0 mm	3.0 mm	2.28 kg	909070001
100.0 mm	2.0 mm	1.74 kg	910050003

Dust covers

to protect the inside of the pipes from dust and dirt



on request

Glass pipes

for pneumatic conveying systems

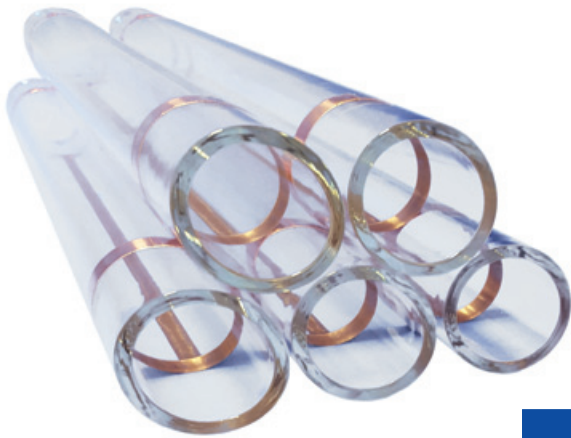

You can find suitable couplings for glass pipes in the glass pipe bend section on Page 50.

You can find coupling stations made of glass on Pages 97 to 98

- Cylindrical glass pipe
- Including radially bonded copper strap
- Fire-polished flat ends
- Distance of the copper earthing strap from the end 50mm
- Material: Borosilicate glass 3.3

Glass pipes			
Outer pipe diameter	Wall thickness	Length	Article number
47.0 mm	5.0 mm	300 mm	9047GL003
47.0 mm	5.0 mm	1500 mm	9047GL001
56.0 mm	5.0 mm	300 mm	9056GL004
56.0 mm	5.0 mm	1500 mm	9056GL002
66.0 mm	5.0 mm	300 mm	9066GL004
66.0 mm	5.0 mm	1500 mm	9066GL001

Sight glasses for conveyor pipes

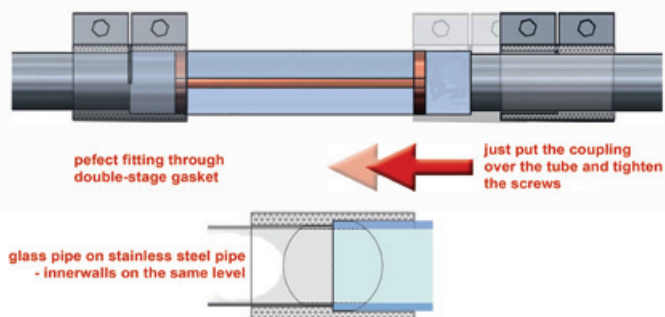

- Real glass pipe (borosilicate glass 3.3)
- Fire-polished pipe ends
- Sight length: 200 mm
- Incl. copper earthing strap
- Two aluminium pipe couplings
- Continuous stepped ring gasket
- Natural black rubber
- Temperature-resistant: -20° to +60°C

Outer pipe diameter	Wall thickness	Article number
47.0 mm	5.0 mm	9047SG300
56.0 mm	5.0 mm	9056SG300
66.0 mm	5.0 mm	9066SG300

Sight glasses also suitable for retrofitting.

Pipe couplings

for fast and easy installation

Our pipe couplings have an ideal price-performance ratio and are particularly easy to install.

- No welding necessary – thus reliable and safe installation
- With stainless steel earthing strap to ensure electrical conductivity
- Metal casing made of aluminium AlMgSi 0.5 F18
- Massive aluminium clamping jaws with double-locking system
- Circular version, thus very easy to install



see the video
on our website

The right pipe coupling for all purposes:

Nitrile* (white)**

-20 °C +80 °C

Natural rubber – black**

-20 °C +60 °C

EPDM* (white)**

-30 °C +120 °C

Neoprene – resistant to weather conditions

-30 °C +100 °C

Silikone* – heat-resistant

-60 °C +200 °C

Viton – resistant to chemical influences

-20 °C +250 °C

*Safe for use with food | **In stock



You can find Individual gaskets as spare parts
in the accessories section on page 108

DVK-HD[®] High pressure

for pipe diameters from 60.3 to 206.0 mm



Pressure conveying

- pressure-resistant up to max. 12 bar / vacuum-resistant up to 0.8 bar
- from -20 °C to +80 °C
- safe for use with food
- all standard diameters immediately available from stock

fast & safe connections

● Immediately available from stock

DVK 6

for pipe diameters from 33.7 to 110.0 mm



Suction conveying

- pressure-resistant up to max. 6 bar / vacuum-resistant up to 0.6 bar
- from -20 °C to +60 °C
- safe for use with food
- all standard diameters immediately available from stock

Pipe couplings DVK-HD® high pressure for heavy-duty pressure conveying (heavy version)



Our pipe couplings have an ideal
price-performance ratio
and are particularly easy to install.

Patented at the
German Patent Office, Munich
Patent No. 10 2008 031 485

DVK-HD® High pressure

- For outer pipe diameters from 60.3 to 206.0 mm
- Length 100, 150 and 200 mm or longer
- Pressure surge-resistant up to max. 12 bar, vacuum-resistant up to 0.8 bar
- Standard: with white nitrile gasket from -20 °C to + 80 °C
- Safe for use with food
- M12 screws with massive threaded bars
- No welding necessary - thus reliable and safe installation
- With stainless steel grounding stripe for electrical conductivity
- Metal casing made of aluminium AlMgSi 0,5 F18
- Massive aluminium clamping jaws with double-locking system
- Circular version, thus very easy to install
- All standard diameters immediately available from stock

**special gaskets at request: EPDM, silicone,
viton and other gasket-materials**



Pipe couplings DVK-HD® high pressure

Pipe couplings DVK-HD® length 150 mm – 3 screws						
Diameter	Length	Gasket	Vacuum-resistant	Pressure-resistant	Weight	Article number
60.3 mm	150 mm	Nitrile white	0.8 bar	18.0 bar	1.1 kg	406036H66
70.0 mm	150 mm	Nitrile white	0.6 bar	18.0 bar	1.1 kg	407036H66
76.1 mm	150 mm	Nitrile white	0.8 bar	18.0 bar	1.2 kg	407636H66
80.0 mm	150 mm	Nitrile white	0.8 bar	16.0 bar	1.2 kg	408036H66
84.0 mm	150 mm	Nitrile white	0.8 bar	12.0 bar	1.2 kg	408436H66
85.0 mm	150 mm	EPDM white	0.8 bar	12.0 bar	1.2 kg	408536H06
88.9 mm	150 mm	Nitrile white	0.8 bar	12.0 bar	1.3 kg	408836H66
90.0 mm	150 mm	EPDM white	0.8 bar	10.0 bar	1.2 kg	409036H06
100.0 mm	150 mm	Nitrile white	0.8 bar	10.0 bar	1.4 kg	410036H66
101.6 mm	150 mm	Nitrile white	0.8 bar	10.0 bar	1.4 kg	410136H66
104.0 mm	150 mm	Nitrile white	0.8 bar	10.0 bar	1.4 kg	410436H66
106.0 mm	150 mm	EPDM white	0.8 bar	8.0 bar	1.3 kg	410636H06
108.0 mm	150 mm	Nitrile white	0.8 bar	10.0 bar	1.5 kg	410836H66
110.0 mm	150 mm	EPDM white	0.8 bar	8.0 bar	1.4 kg	411036H06
114.3 mm	150 mm	Nitrile white	0.8 bar	6.0 bar	1.5 kg	411436H66
125.0 mm	150 mm	Nitrile white	0.8 bar	4.0 bar	1.6 kg	412536H66
127.0 mm	150 mm	Nitrile white	0.8 bar	4.0 bar	1.8 kg	412736H66
128.0 mm	150 mm	Nitrile white	0.8 bar	4.0 bar	1.7 kg	412836H66
129.0 mm	150 mm	Nitrile white	0.8 bar	4.0 bar	1.7 kg	412936H66
133.0 mm	150 mm	Nitrile white	0.8 bar	3.0 bar	1.8 kg	413336H66
139.7 mm	150 mm	Nitrile white	0.8 bar	2.5 bar	1.8 kg	413936H66
154.0 mm	150 mm	Nitrile white	0.8 bar	2.5 bar	1.9 kg	415436H66
156.0 mm	150 mm	Nitrile white	0.8 bar	2.5 bar	1.9 kg	415636H66
159.0 mm	150 mm	Natural black rubber	0.6 bar	1.0 bar	2.1 kg	415936H02
159.0 mm	150 mm	Nitrile white	0.8 bar	1.0 bar	2.1 kg	415936H66
168.3 mm	150 mm	Nitrile white	0.4 bar	1.0 bar	2.1 kg	416836H66
204.0 mm	150 mm	Nitrile white	0.3 bar	0.8 bar	2.7 kg	420436H66
206.0 mm	150 mm	Nitrile white	0.3 bar	0.5 bar	2.7 kg	420636H66



Pipe couplings DVK-HD® length 100 mm – 2 screws						
Diameter	Length	Gasket	Vacuum-resistant	Pressure-resistant	Weight	Article number
○ 60.3 mm	100 mm	Nitrile white	0.6 bar	8 bar	0.8 kg	406036H65
70.0 mm	100 mm	Nitrile white	0.6 bar	8 bar	0.8 kg	407036H65
76.1 mm	100 mm	Nitrile white	0.6 bar	7 bar	0.8 kg	407636H65
80.0 mm	100 mm	Nitrile white	0.6 bar	6 bar	0.8 kg	408036H65
○ 84.0 mm	100 mm	Nitrile white	0.6 bar	6 bar	0.8 kg	408436H65
88.9 mm	100 mm	Nitrile white	0.6 bar	6 bar	0.9 kg	408836H65
100.0 mm	100 mm	Nitrile white	0.6 bar	5 bar	0.9 kg	410036H65
101.6 mm	100 mm	Nitrile white	0.6 bar	5 bar	0.9 kg	410136H65
104.0 mm	100 mm	Nitrile white	0.6 bar	5 bar	0.9 kg	410436H65
○ 108.0 mm	100 mm	Nitrile white	0.6 bar	4 bar	1.0 kg	410836H65
114.3 mm	100 mm	Nitrile white	0.6 bar	1 bar	1.0 kg	411436H65

○ = no stock article | available at short notice

Pipe couplings DVK-HD® high pressure



Pipe couplings DVK-HD® length 200 mm – 4 screws

Diameter	Length	Gasket	Vacuum-resistant	Pressure-resistant	Weight	Article number	
60.3 mm	200 mm	Nitrile white	0.8 bar	20 bar	1.5 kg	406036H67	○
70.0 mm	200 mm	Nitrile white	0.8 bar	20 bar	1.5 kg	407036H67	
76.1 mm	200 mm	Nitrile white	0.8 bar	20 bar	1.6 kg	407636H67	
80.0 mm	200 mm	Nitrile white	0.8 bar	18 bar	1.6 kg	408036H67	
84.0 mm	200 mm	Nitrile white	0.8 bar	14 bar	1.7 kg	408436H67	
85.0 mm	200 mm	EPDM white	0.8 bar	14 bar	1.7 kg	408536H07	
88.9 mm	200 mm	Nitrile white	0.8 bar	14 bar	1.7 kg	408836H67	
90.0 mm	200 mm	EPDM white	0.8 bar	10 bar	1.7 kg	409036H07	○
100.0 mm	200 mm	Nitrile white	0.8 bar	11 bar	1.9 kg	410036H67	
101.6 mm	200 mm	Nitrile white	0.8 bar	11 bar	1.9 kg	410136H67	
104.0 mm	200 mm	Nitrile white	0.8 bar	11 bar	1.9 kg	410436H67	
106.0 mm	200 mm	EPDM white	0.8 bar	9 bar	1.8 kg	410636H07	
108.0 mm	200 mm	Nitrile white	0.8 bar	11 bar	2.0 kg	410836H67	
110.0 mm	200 mm	EPDM white	0.8 bar	9 bar	2.0 kg	411036H07	
114.3 mm	200 mm	Nitrile white	0.8 bar	10 bar	2.0 kg	411436H67	
125.0 mm	200 mm	Nitrile white	0.6 bar	5 bar	2.3 kg	412536H67	
127.0 mm	200 mm	Nitrile white	0.6 bar	5 bar	2.3 kg	412736H67	
129.0 mm	200 mm	Nitrile white	0.6 bar	5 bar	2.2 kg	412936H67	
133.0 mm	200 mm	Nitrile white	0.6 bar	4.5 bar	2.5 kg	413336H67	
139.7 mm	200 mm	Nitrile white	0.6 bar	4 bar	2.5 kg	413936H67	
154.0 mm	200 mm	Nitrile white	0.6 bar	2.5 bar	2.7 kg	415436H67	
159.0 mm	200 mm	Nitrile white	0.6 bar	1.5 bar	2.8 kg	415936H67	
168.3 mm	200 mm	Nitrile white	0.5 bar	1.5 bar	2.8 kg	416836H67	
168.3 mm	300 mm	Nitrile white	0.8 bar	1.5 bar	4.2 kg	416836H69	○
204.0 mm	200 mm	Nitrile white	0.3 bar	1 bar	3.6 kg	420436H67	
204.0 mm	250 mm	Nitrile white	0.4 bar	1 bar	4.5 kg	420436H68	
206.0 mm	200 mm	Nitrile white	0.3 bar	0.8 bar	3.6 kg	420636H67	○

no stock article | available at short notice = ○

Pipe couplings DVK-HD[®] high pressure in anodized version



Anodized version of pipe couplings have been developed especially for use in outside area.

Furthermore these couplings are equipped with: stainless steel screws, nuts and threaded bars to be resistant to weathering.

Further DVK-HD and DVK-6 couplings in anodized version - available at request

Pipe couplings DVK HD[®] Nitrile – Silver anodized, length 150 mm – 3 screws

Diameter	Length	Gasket	Vacuum-resistant	Pressure-resistant	Weight	Article number
60.3 mm	150 mm	Nitrile white	0.8 bar	18.0 bar	1.1 kg	4060S6H66-E
76.1 mm	150 mm	Nitrile white	0.8 bar	18.0 bar	1.2 kg	4076S6H66-E
84.0 mm	150 mm	Nitrile white	0.8 bar	12.0 bar	1.2 kg	4084S6H66-E
88.9 mm	150 mm	Nitrile white	0.8 bar	12.0 bar	1.3 kg	4088S6H66-E
100.0 mm	150 mm	Nitrile white	0.8 bar	10.0 bar	1.4 kg	4100S6H66-E
101.6 mm	150 mm	Nitrile white	0.8 bar	10.0 bar	1.4 kg	4101S6H66-E
104.0 mm	150 mm	Nitrile white	0.8 bar	10.0 bar	1.4 kg	4104S6H66-E
114.3 mm	150 mm	Nitrile white	0.8 bar	9.0 bar	1.5 kg	4114S6H66-E
129.0 mm	150 mm	Nitrile white	0.8 bar	4.0 bar	1.7 kg	4129S6H66-E
139.7 mm	150 mm	Nitrile white	0.8 bar	2.5 bar	1.8 kg	4139S6H66-E
154.0 mm	150 mm	Nitrile white	0.8 bar	2.5 bar	1.9 kg	4154S6H66-E
168.3 mm	150 mm	Nitrile white	0.4 bar	1.0 bar	2.1 kg	4168S6H66-E

Stainless steel pipe couplings



available
at request

Stainless steel pipe couplings
Material no. AISI 304 are available from
diameters 70.0 mm to 206.0 mm

also available in material
AISI 316 L / AISI 316 Ti

Plug for DVK-HD

to seal the coupling head

For food industry and clean room applications

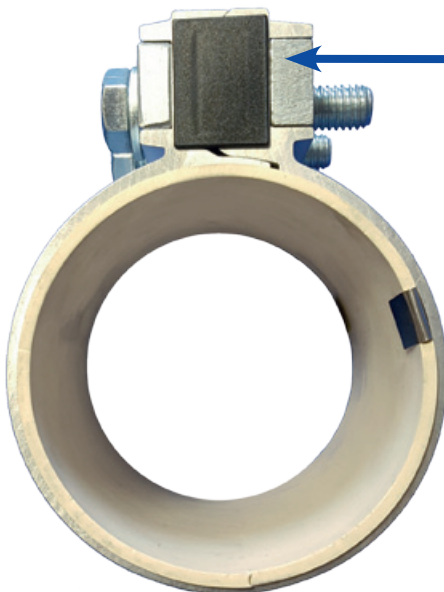

available
at request



Pipe coupling DVK-HD®

Quick closure



available
at request

DVK-HD® **quick closure** pipe couplings are ideal for a quick and safe mounting in pressure conveyors.

The coupling is closed with two clamping levers, therefore a quick opening and closing of pipe connections is possible.

The clamping lever can be locked in any desired position by a simple upward pull.

Pipe couplings type DVK-HD® **quick closure** have the following characteristics:

DVK-HD® **Quick closure**

- for outer pipe diameter 60.3 mm to 168.3 mm
- Casing made of aluminium AlMgSi 0,5 F22
- Vacuum-resistant up to max. 0.2 bar
- With light nitrile gasket or EPDM-gasket
- food-safe
- TÜV tested

Bridge part traction relief

for DVK HD® high pressure

bridge part traction relief also mountable afterwards available at short notice



Also mountable afterwards:

- Clamps: galvanized steel
- Traction bars: aluminium

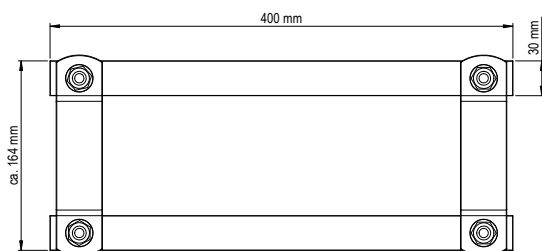
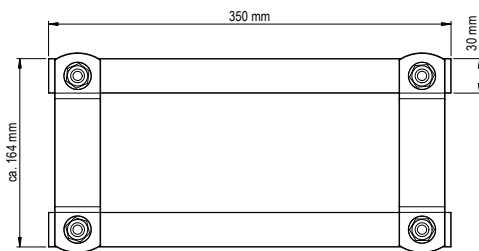

Bridge part traction relief length 350 mm for DVK HD® length 150 mm

for outer pipe diameter	Article number
60.3 mm	Z0602N350
70.0 mm	Z0702N350
76.1 mm	Z0762N350
80.0 mm	Z0802N350
84.0 mm	Z0842N350
88.9 mm	Z0882N350
100.0 mm	Z1002N350
101.6 mm	Z1012N350
104.0 mm	Z1042N350
106.0 mm	Z1062N350
108.0 mm	Z1082N350
110.0 mm	Z1102N350
114.3 mm	Z1142N350
125.0 mm	Z1252N350
129.0 mm	Z1292N350
133.0 mm	Z1332N350
139.7 mm	Z1392N350
154.0 mm	Z1542N350

Bridge part traction relief length 400 mm for DVK HD® length 200 mm

for outer pipe diameter	Article number
60.3 mm	Z0602N400
70.0 mm	Z0702N400
76.1 mm	Z0762N400
80.0 mm	Z0802N400
84.0 mm	Z0842N400
88.9 mm	Z0882N400
100.0 mm	Z1002N400
101.6 mm	Z1012N400
104.0 mm	Z1042N400
106.0 mm	Z1062N400
108.0 mm	Z1082N400
110.0 mm	Z1102N400
114.3 mm	Z1142N400
125.0 mm	Z1252N400
129.0 mm	Z1292N400
133.0 mm	Z1332N400
139.7 mm	Z1392N400
154.0 mm	Z1542N400

Pipe couplings DVK-HD® with Traction relief

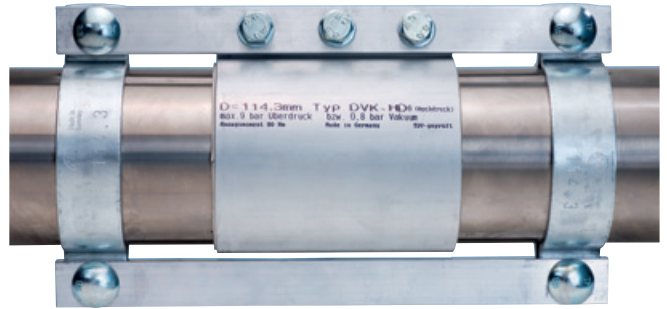
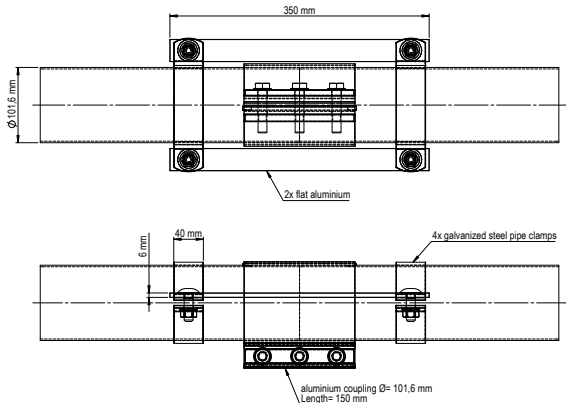

Pipe couplings DVK HD® Nitrile – traction relief, length 150 mm – 3 screws

Diameter	Length	Gasket	Vacuum-resistant	Pressure-resistant	Article number
60.3 mm	150 mm	Nitrile white	0.8 bar	16.0 bar	406038H66
70.0 mm	150 mm	Nitrile white	0.8 bar	18.0 bar	407038H66
76.1 mm	150 mm	Nitrile white	0.8 bar	18.0 bar	407638H66
80.0 mm	150 mm	Nitrile white	0.8 bar	16.0 bar	408038H66
84.0 mm	150 mm	Nitrile white	0.8 bar	12.0 bar	408438H66
88.9 mm	150 mm	Nitrile white	0.8 bar	12.0 bar	408838H66
100.0 mm	150 mm	Nitrile white	0.8 bar	10.0 bar	410038H66
101.6 mm	150 mm	Nitrile white	0.8 bar	10.0 bar	410138H66
104.0 mm	150 mm	Nitrile white	0.8 bar	10.0 bar	410438H66
108.0 mm	150 mm	Nitrile white	0.8 bar	10.0 bar	410838H66
114.3 mm	150 mm	Nitrile white	0.8 bar	9.0 bar	411438H66
125.0 mm	150 mm	Nitrile white	0.8 bar	4.0 bar	412538H66
127.0 mm	150 mm	Nitrile white	0.8 bar	4.0 bar	412738H66
129.0 mm	150 mm	Nitrile white	0.8 bar	4.0 bar	412938H66
133.0 mm	150 mm	Nitrile white	0.8 bar	3.0 bar	413338H66
139.7 mm	150 mm	Nitrile white	0.8 bar	2.5 bar	413938H66
154.0 mm	150 mm	Nitrile white	0.8 bar	2.5 bar	415438H66
168.0 mm	150 mm	Nitrile white	0.8 bar	2.5 bar	416838H66
204.0 mm	150 mm	Nitrile white	0.8 bar	at request	420438H66
206.0 mm	150 mm	Nitrile white	0.8 bar	at request	420638H66

○ = no stock article | available at short notice

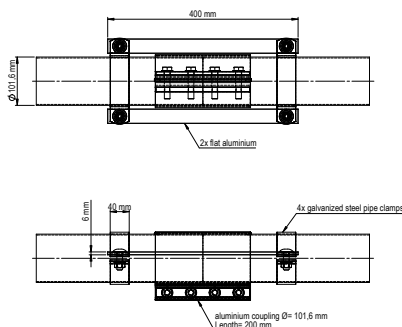

Pipe couplings DVK-HD® with traction-relief

Pipe bends

Pipes

Pipe couplings

Branch pipes

Reducers

Suction lances

Coupling stations

Special parts

PU-Hoses

Accessories

Pipe coupling DVK-HD® Nitrile – traction-relief, length 200 mm – 4 screws

Diameter	Length	Gasket	Vacuum-resistant	Pressure-resistant	Article number	
60.3 mm	200 mm	Nitrile white	0.8 bar	20.0 bar	406038H67	○
70.0 mm	200 mm	Nitrile white	0.8 bar	20.0 bar	407038H67	○
76.1 mm	200 mm	Nitrile white	0.8 bar	22.0 bar	407638H67	○
80.0 mm	200 mm	Nitrile white	0.8 bar	18.0 bar	408038H67	○
84.0 mm	200 mm	Nitrile white	0.8 bar	14.0 bar	408438H67	○
88.9 mm	200 mm	Nitrile white	0.8 bar	14.0 bar	408838H67	○
100.0 mm	200 mm	Nitrile white	0.8 bar	11.0 bar	410038H67	○
101.6 mm	200 mm	Nitrile white	0.8 bar	11.0 bar	410138H67	○
104.0 mm	200 mm	Nitrile white	0.8 bar	11.0 bar	410438H67	○
108.0 mm	200 mm	Nitrile white	0.8 bar	11.0 bar	410838H67	○
114.3 mm	200 mm	Nitrile white	0.8 bar	10.0 bar	411438H67	○
125.0 mm	200 mm	Nitrile white	0.8 bar	5.0 bar	412538H67	○
127.0 mm	200 mm	Nitrile white	0.8 bar	5.0 bar	412738H67	○
129.0 mm	200 mm	Nitrile white	0.8 bar	5.0 bar	412938H67	○
133.0 mm	200 mm	Nitrile white	0.8 bar	4.5 bar	413338H67	○
139.7 mm	200 mm	Nitrile white	0.8 bar	4.0 bar	413938H67	○
154.0 mm	200 mm	Nitrile white	0.8 bar	4.0 bar	415438H67	○
168.0 mm	200 mm	Nitrile white	0.8 bar	4.0 bar	416838H67	○
204.0 mm	200 mm	Nitrile white	0.8 bar	at request	420438H67	○
206.0 mm	200 mm	Nitrile white	0.8 bar	at request	420638H67	○

Pipe couplings DVK-HD® EPDM – traction relief

Diameter	Length	Gasket	Vacuum-resistant	Pressure-resistant	Article number	
85.0 mm	150 mm	EPDM white	0.8 bar	12.0 bar	408538H06	○
85.0 mm	200 mm	EPDM white	0.8 bar	14.0 bar	408538H07	○
90.0 mm	150 mm	EPDM white	0.8 bar	9.0 bar	409038H06	○
90.0 mm	200 mm	EPDM white	0.8 bar	10.0 bar	409038H07	○
106.0 mm	150 mm	EPDM white	0.8 bar	8.0 bar	410638H06	○
106.0 mm	200 mm	EPDM white	0.8 bar	9.0 bar	410638H07	○
110.0 mm	150 mm	EPDM white	0.8 bar	8.0 bar	411038H06	○
110.0 mm	200 mm	EPDM white	0.8 bar	9.0 bar	411038H07	○

no stock article | available at short notice = ○

Pipe couplings DVK 6 for suction conveying (light version)



Our pipe couplings have an ideal price-performance ratio and are particularly easy to install.

DVK 6

- For outer pipe diameters from 33.7 to 110.0 mm
- Length 100, 150 mm or longer
- Vacuum-resistant to 0.6 bar – pressure-resistant to max. 6 bar
- **Standard: black natural rubber gasket from -20 °C to + 60 °C**
- **Alternatively: white EPDM-gasket from -30 °C to + 120 °C**
- **Special gaskets on request: nitrile gasket / silicone / viton**
- All standard-diameters immediately available from stock
- Anodized version with stainless steel screws also available at request



Pipe couplings DVK 6

Gasket: Natural black rubber

Pipe couplings DVK 6 Natural rubber, length 100 mm – 2 screws

Diameter	Length	Gasket	Vacuum-resistant	Pressure-resistant	Weight	Article number
38.0 mm	100 mm	Natural black rubber	0.6 bar	6.0 bar	0.3 kg	403835H01
40.0 mm	100 mm	Natural black rubber	0.6 bar	6.0 bar	0.3 kg	404035H01
45.0 mm	100 mm	Natural black rubber	0.6 bar	6.0 bar	0.3 kg	404535H01
48.3 mm	100 mm	Natural black rubber	0.6 bar	6.0 bar	0.5 kg	404835H01
50.0 mm	100 mm	Natural black rubber	0.6 bar	6.0 bar	0.3 kg	405035H01
50.8 mm	100 mm	Natural black rubber	0.6 bar	6.0 bar	0.3 kg	405135H01
54.0 mm	100 mm	Natural black rubber	0.6 bar	6.0 bar	0.3 kg	405435H01
60.3 mm	100 mm	Natural black rubber	0.6 bar	6.0 bar	0.4 kg	406035H01
63.5 mm	100 mm	Natural black rubber	0.5 bar	5.0 bar	0.4 kg	406335H01
65.0 mm	100 mm	Natural black rubber	0.5 bar	4.0 bar	0.4 kg	406535H01
70.0 mm	100 mm	Natural black rubber	0.5 bar	3.5 bar	0.4 kg	407035H01
76.1 mm	100 mm	Natural black rubber	0.5 bar	1.5 bar	0.6 kg	407635H01
80.0 mm	100 mm	Natural black rubber	0.5 bar	1.5 bar	0.5 kg	408035H01
84.0 mm	100 mm	Natural black rubber	0.5 bar	1.5 bar	0.5 kg	408435H01
88.9 mm	100 mm	Natural black rubber	0.5 bar	1.0 bar	0.5 kg	408835H01
100.0 mm	100 mm	Natural black rubber	0.5 bar	0.5 bar	0.6 kg	410035H01
101.6 mm	100 mm	Natural black rubber	0.5 bar	0.5 bar	0.5 kg	410135H01
104.0 mm	100 mm	Natural black rubber	0.5 bar	0.5 bar	0.6 kg	410435H01
108.0 mm	100 mm	Natural black rubber	0.5 bar	0.5 bar	0.6 kg	410835H01
110.0 mm	100 mm	Natural black rubber	0.5 bar	0.5 bar	0.6 kg	411035H01

Pipe couplings DVK 6

Gasket: Natural black rubber



Pipe couplings DVK 6 Natural rubber, length 150 mm – 3 screws

Diameter	Length	Gasket	Vacuum-resistant	Pressure-resistant	Weight	Article number
38.0 mm	150 mm	Natural black rubber	0.6 bar	6.0 bar	0.4 kg	403835H02
40.0 mm	150 mm	Natural black rubber	0.6 bar	6.0 bar	0.4 kg	404035H02
45.0 mm	150 mm	Natural black rubber	0.6 bar	6.0 bar	0.5 kg	404535H02
48.3 mm	150 mm	Natural black rubber	0.6 bar	6.0 bar	0.5 kg	404835H02
50.0 mm	150 mm	Natural black rubber	0.6 bar	6.0 bar	0.5 kg	405035H02
50.8 mm	150 mm	Natural black rubber	0.6 bar	6.0 bar	0.5 kg	405135H02
54.0 mm	150 mm	Natural black rubber	0.6 bar	6.0 bar	0.5 kg	405435H02
60.3 mm	150 mm	Natural black rubber	0.6 bar	6.0 bar	0.5 kg	406035H02
63.5 mm	150 mm	Natural black rubber	0.6 bar	6.0 bar	0.6 kg	406335H02
65.0 mm	150 mm	Natural black rubber	0.6 bar	6.0 bar	0.6 kg	406535H02
70.0 mm	150 mm	Natural black rubber	0.6 bar	6.0 bar	0.6 kg	407035H02
76.1 mm	150 mm	Natural black rubber	0.5 bar	1.5 bar	0.7 kg	407635H02
80.0 mm	150 mm	Natural black rubber	0.5 bar	1.5 bar	0.7 kg	408035H02
84.0 mm	150 mm	Natural black rubber	0.5 bar	1.5 bar	0.7 kg	408435H02
88.9 mm	150 mm	Natural black rubber	0.5 bar	1.5 bar	0.8 kg	408835H02
100.0 mm	150 mm	Natural black rubber	0.5 bar	1.5 bar	0.9 kg	410035H02
101.6 mm	150 mm	Natural black rubber	0.5 bar	1.5 bar	0.8 kg	410135H02
104.0 mm	150 mm	Natural black rubber	0.5 bar	1.0 bar	0.9 kg	410435H02
108.0 mm	150 mm	Natural black rubber	0.5 bar	1.0 bar	1.0 kg	410835H02
110.0 mm	150 mm	Natural black rubber	0.5 bar	1.0 bar	0.9 kg	411035H02



Pipe couplings DVK 6

Gasket: EPDM white

Pipe couplings DVK 6 EPDM, length 100 mm – 2 screws						
Diameter	Length	Gasket	Vacuum-resistant	Pressure-resistant	Weight	Article number
38.0 mm	100 mm	EPDM white	0.6 bar	6.0 bar	0.3 kg	403835H05
40.0 mm	100 mm	EPDM white	0.6 bar	6.0 bar	0.3 kg	404035H05
45.0 mm	100 mm	EPDM white	0.6 bar	6.0 bar	0.3 kg	404535H05
48.3 mm	100 mm	EPDM white	0.6 bar	6.0 bar	0.3 kg	404835H05
50.0 mm	100 mm	EPDM white	0.6 bar	6.0 bar	0.3 kg	405035H05
50.8 mm	100 mm	EPDM white	0.6 bar	6.0 bar	0.3 kg	405135H05
54.0 mm	100 mm	EPDM white	0.6 bar	6.0 bar	0.3 kg	405435H05
60.3 mm	100 mm	EPDM white	0.6 bar	6.0 bar	0.4 kg	406035H05
63.5 mm	100 mm	EPDM white	0.5 bar	5.0 bar	0.5 kg	406335H05
65.0 mm	100 mm	EPDM white	0.5 bar	4.0 bar	0.4 kg	406535H05
70.0 mm	100 mm	EPDM white	0.5 bar	3.5 bar	0.4 kg	407035H05
76.1 mm	100 mm	EPDM white	0.5 bar	1.5 bar	0.5 kg	407635H05
80.0 mm	100 mm	EPDM white	0.5 bar	1.5 bar	0.5 kg	408035H05
84.0 mm	100 mm	EPDM white	0.5 bar	1.5 bar	0.5 kg	408435H05
88.9 mm	100 mm	EPDM white	0.5 bar	1.0 bar	0.5 kg	408835H05
100.0 mm	100 mm	EPDM white	0.5 bar	0.5 bar	0.5 kg	410035H05
101.6 mm	100 mm	EPDM white	0.5 bar	0.5 bar	0.5 kg	410135H05
104.0 mm	100 mm	EPDM white	0.5 bar	0.5 bar	0.6 kg	410435H05
108.0 mm	100 mm	EPDM white	0.5 bar	0.5 bar	0.6 kg	410835H05
110.0 mm	100 mm	EPDM white	0.5 bar	0.5 bar	0.6 kg	411035H05

Pipe couplings DVK 6 EPDM, length 150 mm – 3 screws

Diameter	Length	Gasket	Vacuum-resistant	Pressure-resistant	Weight	Article number
38.0 mm	150 mm	EPDM white	0.6 bar	6.0 bar	0.4 kg	403835H06
40.0 mm	150 mm	EPDM white	0.6 bar	6.0 bar	0.5 kg	404035H06
45.0 mm	150 mm	EPDM white	0.6 bar	6.0 bar	0.5 kg	404535H06
48.3 mm	150 mm	EPDM white	0.6 bar	6.0 bar	0.5 kg	404835H06
50.0 mm	150 mm	EPDM white	0.6 bar	6.0 bar	0.5 kg	405035H06
50.8 mm	150 mm	EPDM white	0.6 bar	6.0 bar	0.5 kg	405135H06
54.0 mm	150 mm	EPDM white	0.6 bar	6.0 bar	0.5 kg	405435H06
60.3 mm	150 mm	EPDM white	0.6 bar	6.0 bar	0.5 kg	406035H06
63.5 mm	150 mm	EPDM white	0.6 bar	6.0 bar	0.5 kg	406335H06
65.0 mm	150 mm	EPDM white	0.6 bar	6.0 bar	0.6 kg	406535H06
70.0 mm	150 mm	EPDM white	0.6 bar	6.0 bar	0.6 kg	407035H06
76.1 mm	150 mm	EPDM white	0.5 bar	1.5 bar	0.7 kg	407635H06
80.0 mm	150 mm	EPDM white	0.7 bar	1.5 bar	0.7 kg	408035H06
84.0 mm	150 mm	EPDM white	0.5 bar	1.5 bar	0.7 kg	408435H06
88.9 mm	150 mm	EPDM white	0.5 bar	1.5 bar	0.8 kg	408835H06
100.0 mm	150 mm	EPDM white	0.5 bar	1.5 bar	0.9 kg	410035H06
101.6 mm	150 mm	EPDM white	0.5 bar	1.5 bar	0.8 kg	410135H06
104.0 mm	150 mm	EPDM white	0.5 bar	1.0 bar	0.9 kg	410435H06
108.0 mm	150 mm	EPDM white	0.5 bar	1.0 bar	1.0 kg	410835H06
110.0 mm	150 mm	EPDM white	0.5 bar	1.0 bar	1.0 kg	411035H06

Pipe couplings DVK 6 - Quick closure

DVK-6 pipe couplings with quick closure accelerate mounting in suction conveying with constant safety. The clamping lever can be locked in any position desired by a simple upward pull.

A high clamping force develops due to optimal length of lever.



available at request

- For outer pipe diameter from 33.7 to 110.0 mm
- Length: 150 mm or longer
- Easy to use and timesaving quick closure
- Vacuum-resistant up to max. 0.4 bar
- Pressure-resistant up to max. 2 bar
- Double secured massive aluminium clamps
- Black natural gasket (- 20°C to + 60°C)
- White EPDM gasket (food safe and temperature-resistant from - 30°C to + 120°C)
- Optionally with silicone gasket (- 60°C to + 200°C)

Pipe couplings

DVK 6 with express lock
with fine adjustment

New

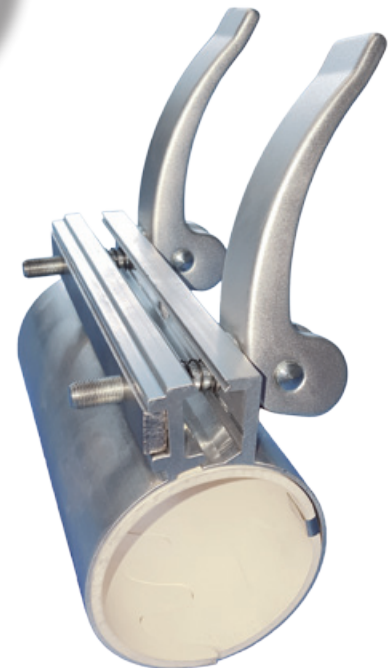
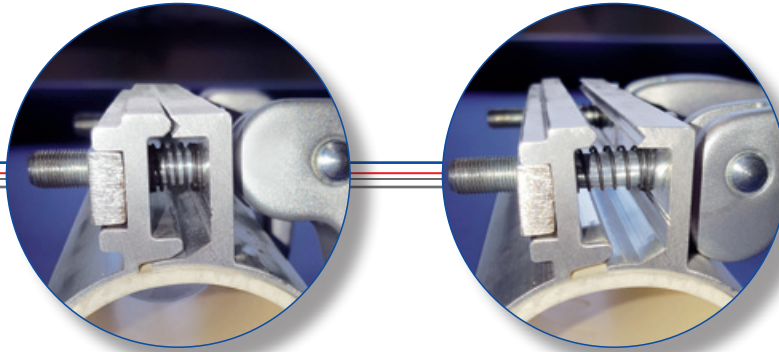

- For outer pipe diameters from 33.7 to 110.0 mm
- With fine adjustment (fine thread)
- With compression spring for quick opening
- Length 150 mm or longer
- Easy-to-use, time-saving quick-action lock
- Vacuum-resistant up to a maximum of 0.4 bar
- Pressure surge-resistant up to max. 2 bar
- Massive aluminium clamping jaws with double-locking system
- White EPDM gasket (safe to use with food and temperature-resistant from -30°C to +120°C)
- Optionally available with silicone gasket (-60°C to +200°C)

Pipe couplings DVK 6 – FIX

In contrast to DVK 6 quick closure pipe couplings, DVK-6 Fix pipe couplings only the upper area of the slit coupling is closed with a clamping lever. The clamping lever can be locked in every desired posi-

tion by a simple upward pull. A high clamping force develops due to optimal length of lever.

available at request



- for outer pipe diameter from 38.0 to 110.0 mm
- Length: 100 mm
- Vacuum-resistant up to max. 0.4 bar
- Pressure-resistant up to max. 2 bar
- M 8 screws with massive threaded bars
- Metall casing made of aluminium (AlMgSi 0,5 F22)
- Massive aluminium clamping jaws with double-locking system
- Circular version, thus very easy to install
- White EPDM gasket (food-safe and temperature-resistant from - 30°C to + 120°C)
- Black natural rubber gasket (- 20°C to + 60°C)
- optionally: silicone gasket for temperatures between - 60°C to + 200°C

DVK 6 with stainless steel inner ring to protect the gasket from abrasive media

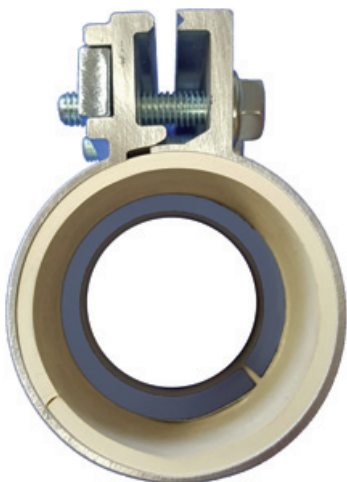

available at request

Pipe couplings for connecting glass pipe bends with stainless steel pipes

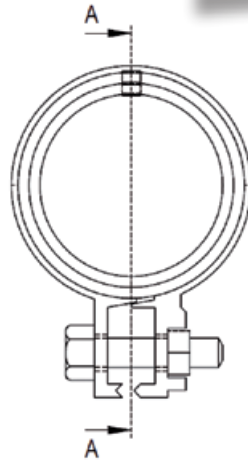
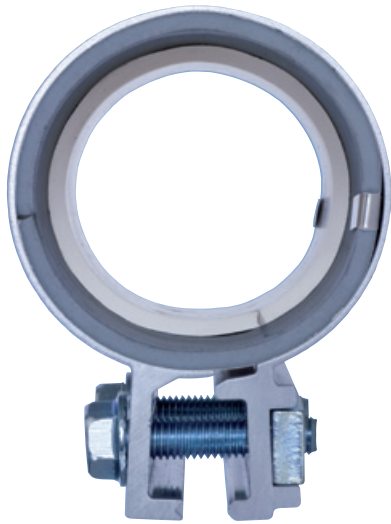

with offset one-piece gasket!

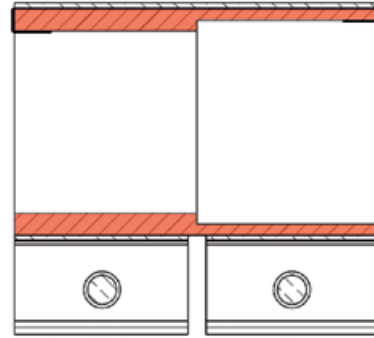

A-A

You can find article numbers on page 50

Plug for DVK-6 to seal the coupling head

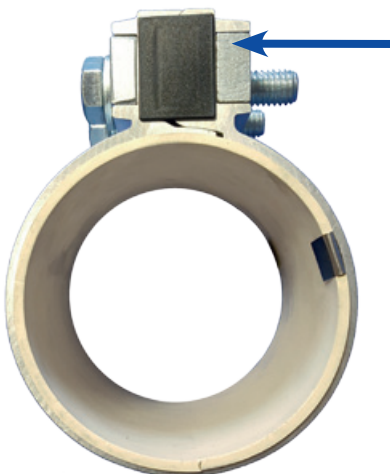

Applications

- Food applications
- Clean room applications

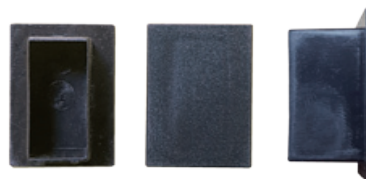

available at request

Stainless steel branch pipes

30° | 45° | 90°

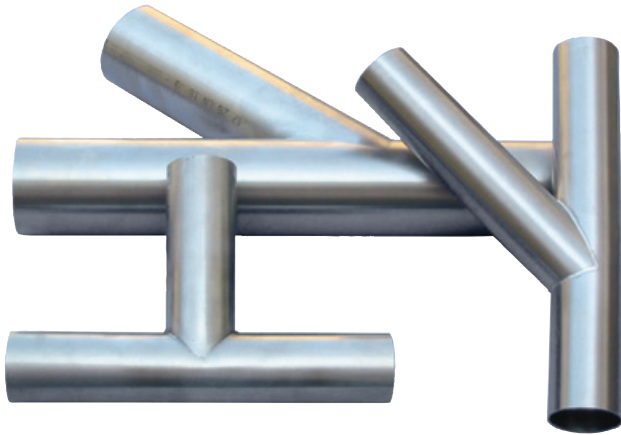

- Material no.: AISI 304 / AISI 304 L
- Laser-cut and welded
- Wall thickness: 1.5 mm / 2.0 mm

**form gas welded
at request**



Stainless steel branch pipes 30°

Material no. AISI 304 / AISI 304 L

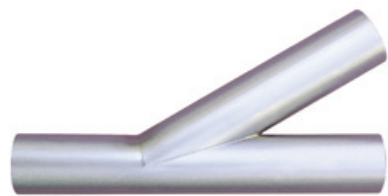

special models
at request

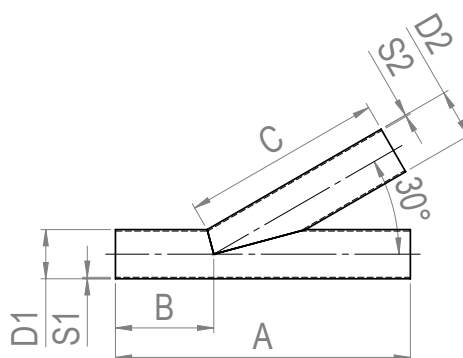

Stainless steel branch pipes 30°

Angle	Diameter	Wall thickness	A	B	C	Weight	Article number
			all information in mm				
30°	38.0 mm	1.5 mm	300.0	106.0	210.0	0.64 kg	803813002
30°	40.0 mm	1.5 mm	300.0	110.0	210.0	0.67 kg	804013001
30°	40.0 mm	2.0 mm	300.0	105.0	209.0	0.88 kg	804013002
30°	45.0 mm	1.5 mm	300.0	104.0	210.0	0.75 kg	804513001
30°	50.0 mm	2.0 mm	300.0	100.0	204.0	1.07 kg	805013002
30°	50.0 mm	1.5 mm	300.0	100.0	210.0	0.82 kg	805013003
30°	54.0 mm	2.0 mm	300.0	100.0	208.0	1.16 kg	805413001
30°	60.3 mm	2.0 mm	350.0	106.0	210.0	1.43 kg	806013001
30°	63.5 mm	2.0 mm	400.0	145.0	261.0	1.80 kg	806313001
30°	65.0 mm	2.0 mm	400.0	145.0	260.0	1.84 kg	806513001
30°	65.0 mm	1.5 mm	400.0	145.0	260.0	1.39 kg	806513002
30°	70.0 mm	2.0 mm	450.0	140.0	280.0	2.20 kg	807013001
30°	76.1 mm	2.0 mm	410.0	140.0	260.0	2.16 kg	807613001
30°	80.0 mm	2.0 mm	500.0	145.0	348.0	2.94 kg	808013001
30°	84.0 mm	2.0 mm	420.0	120.0	300.0	2.55 kg	808413001
30°	85.0 mm	2.0 mm	570.0	200.0	345.0	3.38 kg	808513001
30°	88.9 mm	2.0 mm	480.0	130.0	338.0	3.10 kg	808813001
30°	100.0 mm	1.5 mm	550.0	185.0	351.0	2.89 kg	810013001
30°	101.6 mm	2.0 mm	550.0	185.0	350.0	3.89 kg	810113001
30°	104.0 mm	2.0 mm	550.0	200.0	366.0	4.05 kg	810413001
30°	129.0 mm	2.0 mm	700.0	223.0	450.0	6.34 kg	812913001
30°	139.7 mm	2.0 mm	650.0	160.0	481.0	6.66 kg	813913001
30°	154.0 mm	2.0 mm	650.0	160.0	479.0	7.22 kg	815413001
30°	168.3 mm	2.0 mm	750.0	160.0	577.0	9.39 kg	816813001
30°	204.0 mm	2.0 mm	at request				820413001
30°	206.0 mm	3.0 mm	at request				820613001

Branch pipes up to diameter 254.0 mm - at request

Stainless steel branch pipes 45°

Material no. AISI 304 / AISI 304 L

**formgas welded
at request**

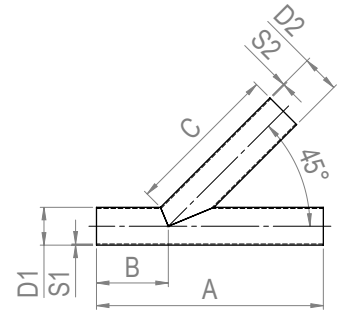
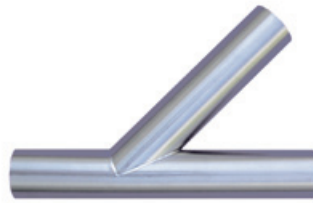

Stainless steel branch pipes 45°

Angle	Diameter	Wall thickness	A	B	C	Weight	Article number
			all information in mm				
45°	38.0 mm	1.5 mm	300.0	103.0	206.0	0.65 kg	803814501
45°	40.0 mm	1.5 mm	300.0	115.0	207.0	0.69 kg	804014501
45°	40.0 mm	2.0 mm	300.0	115.0	207.0	0.91 kg	804014502
45°	45.0 mm	1.5 mm	300.0	101.0	205.0	0.77 kg	804514501
45°	50.0 mm	1.5 mm	300.0	95.0	205.0	0.85 kg	805014501
45°	50.0 mm	2.0 mm	300.0	95.0	185.0	1.08 kg	805014502
45°	54.0 mm	2.0 mm	300.0	95.0	209.0	1.22 kg	805414501
45°	60.3 mm	2.0 mm	350.0	100.0	210.0	1.51 kg	806014501
45°	60.3 mm	1.6 mm	350.0	100.0	210.0	1.21 kg	806014506
45°	63.5 mm	2.0 mm	350.0	145.0	220.0	1.61 kg	806314501
45°	65.0 mm	2.0 mm	350.0	145.0	220.0	1.65 kg	806514501
45°	65.0 mm	1.5 mm	350.0	145.0	220.0	1.24 kg	806514502
45°	70.0 mm	2.0 mm	400.0	105.0	285.0	2.15 kg	807014501
45°	76.1 mm	2.0 mm	410.0	140.0	260.0	2.28 kg	807614501
45°	80.0 mm	2.0 mm	400.0	140.0	240.0	2.27 kg	808014501
45°	80.0 mm	1.5 mm	400.0	140.0	240.0	1.71 kg	808014504
45°	84.0 mm	2.0 mm	370.0	75.0	240.0	2.25 kg	808414501
45°	85.0 mm	2.0 mm	520.0	200.0	283.0	3.07 kg	808514501
45°	88.9 mm	2.0 mm	420.0	130.0	282.0	2.77 kg	808814501
45°	100.0 mm	1.5 mm	450.0	150.0	300.0	2.50 kg	810014501
45°	101.6 mm	2.0 mm	450.0	150.0	300.0	3.37 kg	810114501
45°	104.0 mm	2.0 mm	500.0	170.0	300.0	3.69 kg	810414501
45°	108.0 mm	2.0 mm	500.0	170.0	278.0	3.71 kg	810814501
45°	114.3 mm	2.0 mm	550.0	200.0	325.0	4.45 kg	811414501
45°	129.0 mm	2.0 mm	600.0	223.0	325.0	5.28 kg	812914501
45°	139.7 mm	2.0 mm	550.0	150.0	350.0	5.50 kg	813914501
45°	154.0 mm	2.0 mm	650.0	250.0	380.0	6.98 kg	815414501
45°	168.3 mm	2.0 mm		at request			816814501
45°	204.0 mm	2.0 mm		at request			820414501
45°	206.0 mm	3.0 mm		at request			820614501

Branch pipes up to diameter 254.0 mm - at request

Stainless steel T-pieces (90°)

Material no. AISI 304 / 304 L

**special models
at request**

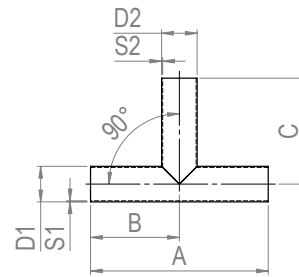

Stainless steel T-pieces 90°

Angle	Diameter	Wall thickness	A	B	C	Weight	Article number
all information in mm							
90°	38,0 mm	1,5 mm	250,0	125,0	143,0	0,50 kg	803819001
90°	40,0 mm	1,5 mm	250,0	125,0	144,0	0,53 kg	804019001
90°	40,0 mm	2,0 mm	250,0	125,0	145,0	0,70 kg	804019002
90°	45,0 mm	1,5 mm	250,0	125,0	148,0	0,60 kg	804519001
90°	50,0 mm	1,5 mm	250,0	125,0	149,0	0,67 kg	805019001
90°	50,0 mm	2,0 mm	250,0	125,0	149,0	0,88 kg	805019002
90°	54,0 mm	2,0 mm	250,0	125,0	152,0	0,95 kg	805419001
90°	60,3 mm	2,0 mm	260,0	130,0	154,0	1,09 kg	806019001
90°	60,3 mm	1,6 mm	250,0	125,0	154,0	0,86 kg	806019002
90°	63,5 mm	2,0 mm	260,0	130,0	156,0	1,15 kg	806319001
90°	65,0 mm	2,0 mm	300,0	150,0	153,0	1,29 kg	806519001
90°	70,0 mm	2,0 mm	300,0	150,0	155,0	1,39 kg	807019001
90°	76,1 mm	2,0 mm	300,0	150,0	158,0	1,51 kg	807619001
90°	80,0 mm	2,0 mm	350,0	175,0	189,0	1,90 kg	808019001
90°	80,0 mm	1,5 mm	350,0	175,0	189,0	1,43 kg	808019002
90°	84,0 mm	2,0 mm	300,0	150,0	191,0	1,79 kg	808419001
90°	85,0 mm	2,0 mm	300,0	150,0	191,0	1,81 kg	808519001
90°	88,9 mm	2,0 mm	300,0	150,0	194,0	1,89 kg	808819001
90°	100,0 mm	1,5 mm	350,0	175,0	200,0	1,79 kg	810019001
90°	101,6 mm	2,0 mm	350,0	175,0	200,0	2,41 kg	810119001
90°	104,0 mm	2,0 mm	350,0	175,0	201,0	2,46 kg	810419001
90°	114,3 mm	2,0 mm	350,0	175,0	207,0	2,71 kg	811419001
90°	129,0 mm	2,0 mm	450,0	225,0	245,0	3,68 kg	812919001
90°	139,7 mm	2,0 mm	450,0	225,0	250,0	4,19 kg	813919001
90°	154,0 mm	2,0 mm	554,0	277,0	277,0	5,54 kg	815419001
90°	168,3 mm	2,0 mm	565,0	282,5	285,0	6,14 kg	816819001
90°	204,0 mm	2,0 mm	at request				820419001
90°	206,0 mm	3,0 mm	at request				820619001

T-pieces up to diameter 254.0 mm - at request

HVA NIRO® Stainless steel branch pipes

Short version for coupling stations

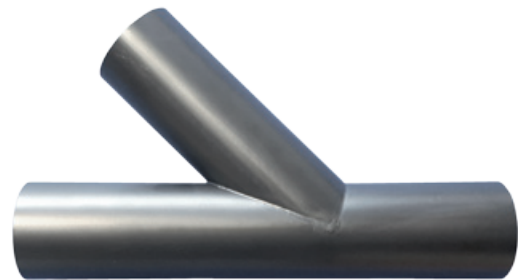
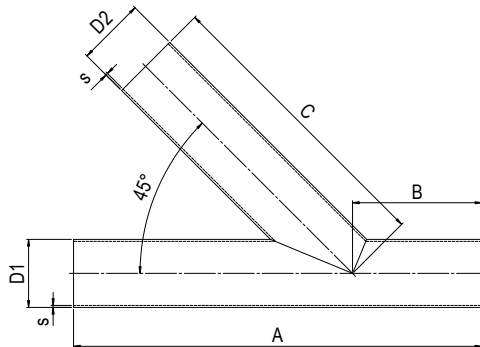

HVA NIRO® Stainless steel branch pipes 45°

Diameter	A	B	C	Article number
40.0 x 1.5 mm	235.0 mm	100.0 mm	135.0 mm	8040145KU-9
45.0 x 1.5 mm	240.5 mm	88.7 mm	140.0 mm	8045145KU-9
50.0 x 1.5 mm	240.5 mm	88.7 mm	140.0 mm	8050145KU-9
60.3 x 2.0 mm	250.0 mm	100.0 mm	222.0 mm	8060145KU-9
60.3 x 1.5 mm	250.0 mm	100.0 mm	222.0 mm	8060145KU/1-9

Glass branch pipes

- Material: Borosilicate glass 3.3
- With glued copper earthing strip
- Edge distance of the copper earthing strip 50 mm



see the video
on our website

Stainless steel reducers

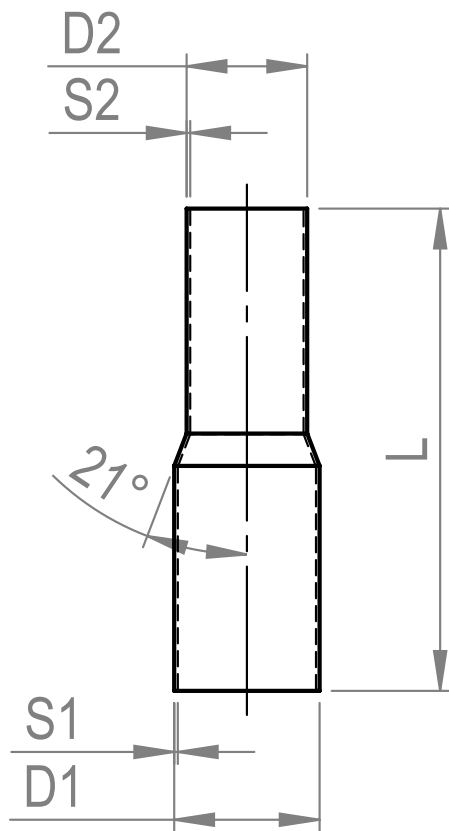

- Outer diameters: 38.0 to 168.3 mm
- Laser-cut
- Deburred
- Concentric version
- Widened with 21° degree
- Material no. AISI 304 / 304L

**special models
at request**

Stainless steel reducers				
D1 Diameter x wall	D2 Diameter x wall	Length L	Weight	Article number
40.0 x 1.5 mm	38.0 x 1.5 mm	150 mm	0.21 kg	80401RZ02
45.0 x 1.5 mm	38.0 x 1.5 mm	150 mm	0.22 kg	80451RZ01
45.0 x 1.5 mm	40.0 x 1.5 mm	120 mm	0.18 kg	80451RZ02
48.3 x 2.0 mm	40.0 x 1.5 mm	200 mm	0.32 kg	80481RZ01

50.0 x 1.5 mm	38.0 x 1.5 mm	150 mm	0.24 kg	80501RZ05
50.0 x 1.5 mm	38.0 x 1.5 mm	200 mm	0.32 kg	80501RZ02
50.0 x 1.5 mm	40.0 x 1.5 mm	120 mm	0.20 kg	80501RZ01
50.0 x 1.5 mm	40.0 x 1.5 mm	150 mm	0.24 kg	80501RZ15
50.0 x 1.5 mm	40.0 x 1.5 mm	200 mm	0.33 kg	80501RZ04
50.0 x 1.5 mm	45.0 x 1.5 mm	120 mm	0.21 kg	80501RZ06
50.0 x 1.5 mm	45.0 x 1.5 mm	150 mm	0.26 kg	80501RZ20

Special models at request

**in other materials
also available**

**special models
at request**

Stainless steel reducers

D1 Diameter x wall	D2 Diameter x wall	Length L	Weight	Article number
54.0 x 2.0 mm	38.0 x 1.5 mm	200 mm	0.33 kg	80541RZ01
54.0 x 2.0 mm	40.0 x 1.5 mm	200 mm	0.34 kg	80541RZ09
54.0 x 2.0 mm	50.0 x 1.5 mm	150 mm	0.28 kg	80541RZ11
54.0 x 2.0 mm	50.0 x 1.5 mm	200 mm	0.38 kg	80541RZ04
54.0 x 2.0 mm	50.0 x 2.0 mm	200 mm	0.50 kg	80541RZ06

60.3 x 2.0 mm	40.0 x 1.5 mm	150 mm	0.28 kg	80601RZ24
60.3 x 2.0 mm	50.0 x 1.5 mm	150 mm	0.30 kg	80601RZ09
60.3 x 2.0 mm	38.0 x 1.5 mm	200 mm	0.36 kg	80601RZ08
60.3 x 2.0 mm	45.0 x 1.5 mm	200 mm	0.38 kg	80601RZ06
60.3 x 2.0 mm	50.0 x 1.5 mm	200 mm	0.40 kg	80601RZ04
60.3 x 2.0 mm	54.0 x 2.0 mm	200 mm	0.42 kg	80601RZ07

63.5 x 2.0 mm	50.0 x 1.5 mm	150 mm	0.41 kg	80631RZ05
---------------	---------------	--------	---------	------------------

65.0 x 2.0 mm	50.0 x 1.5 mm	200 mm	0.42 kg	80651RZ02
65.0 x 2.0 mm	54.0 x 2.0 mm	200 mm	0.57 kg	80651RZ14
65.0 x 2.0 mm	60.3 x 2.0 mm	150 mm	0.45 kg	80651RZ06
65.0 x 2.0 mm	60.3 x 2.0 mm	200 mm	0.60 kg	80651RZ07

Special models at request



Stainless steel reducers

Material no. AISI 304 / 304 L

Stainless steel reducers				
D1 Diameter x wall	D2 Diameter x wall	Length L	Weight	Article number
70.0 x 2.0 mm	50.0 x 1.5 mm	200 mm	0.51 kg	80701RZ01
70.0 x 2.0 mm	50.0 x 2.0 mm	200 mm	0.58 kg	80701RZ14
70.0 x 2.0 mm	54.0 x 2.0 mm	150 mm	0.45 kg	80701RZ23
70.0 x 2.0 mm	54.0 x 2.0 mm	200 mm	0.60 kg	80701RZ02
70.0 x 2.0 mm	60.3 x 2.0 mm	200 mm	0.63 kg	80701RZ05
70.0 x 2.0 mm	65.0 x 2.0 mm	200 mm	0.65 kg	80701RZ06

76.1 x 2.0 mm	50.0 x 1.5 mm	200 mm	0.53 kg	80761RZ05
76.1 x 2.0 mm	54.0 x 2.0 mm	250 mm	0.79 kg	80761RZ13
76.1 x 2.0 mm	60.3 x 2.0 mm	120 mm	0.40 kg	80761RZ06
76.1 x 2.0 mm	60.3 x 2.0 mm	150 mm	0.50 kg	80761RZ29
76.1 x 2.0 mm	60.3 x 2.0 mm	200 mm	0.66 kg	80761RZ11
76.1 x 2.0 mm	65.0 x 2.0 mm	200 mm	0.68 kg	80761RZ12
76.1 x 2.0 mm	70.0 x 2.0 mm	200 mm	0.71 kg	80761RZ10

80.0 x 2.0 mm	50.0 x 1.5 mm	300 mm	0.95 kg	80801RZ08
80.0 x 2.0 mm	60.3 x 2.0 mm	200 mm	0.68 kg	80801RZ01
80.0 x 2.0 mm	65.0 x 2.0 mm	200 mm	0.71 kg	80801RZ02
80.0 x 2.0 mm	70.0 x 2.0 mm	200 mm	0.73 kg	80801RZ10
80.0 x 2.0 mm	76.1 x 2.0 mm	200 mm	0.76 kg	80801RZ11

Special models at request

Material no. AISI 304 / 304 L



larger dimensions
at request

Stainless steel reducers

D1 Diameter x wall	D2 Diameter x wall	Length L	Weight	Article number
84.0 x 2.0 mm	80.0 x 2.0 mm	250 mm	0.99 kg	80841RZ04

88.9 x 2.0 mm	60.3 x 2.0 mm	300 mm	1.09 kg	80881RZ14
88.9 x 2.0 mm	70.0 x 2.0 mm	300 mm	1.16 kg	80881RZ12
88.9 x 2.0 mm	76.1 x 2.0 mm	300 mm	1.20 kg	80881RZ09
88.9 x 2.0 mm	80.0 x 2.0 mm	300 mm	1.23 kg	80881RZ02
88.9 x 2.0 mm	84.0 x 2.0 mm	300 mm	1.26 kg	80881RZ10

100.0 x 1.5 mm	50.0 x 1.5 mm	300 mm	0.82 kg	81001RZ03
100.0 x 1.5 mm	70.0 x 2.0 mm	300 mm	1.06 kg	81001RZ09
100.0 x 1.5 mm	80.0 x 2.0 mm	300 mm	1.13 kg	81001RZ07
100.0 x 1.5 mm	88.9 x 2.0 mm	300 mm	1.20 kg	81001RZ04

101.6 x 2.0 mm	70.0 x 2.0 mm	300 mm	1.25 kg	81011RZ10
101.6 x 2.0 mm	76.1 x 2.0 mm	300 mm	1.29 kg	81011RZ11
101.6 x 2.0 mm	88.9 x 2.0 mm	300 mm	1.39 kg	81011RZ02

104.0 x 2.0 mm	76.1 x 2.0 mm	300 mm	1.31 kg	81041RZ08
104.0 x 2.0 mm	80.0 x 2.0 mm	300 mm	1.34 kg	81041RZ13
104.0 x 2.0 mm	84.0 x 2.0 mm	300 mm	1.37 kg	81041RZ06
104.0 x 2.0 mm	88.9 x 2.0 mm	300 mm	1.41 kg	81041RZ09
104.0 x 2.0 mm	100.0 x 1.5 mm	300 mm	1.31 kg	81041RZ03
104.0 x 2.0 mm	101.6 x 2.0 mm	300 mm	1.50 kg	81041RZ10

Special models at request

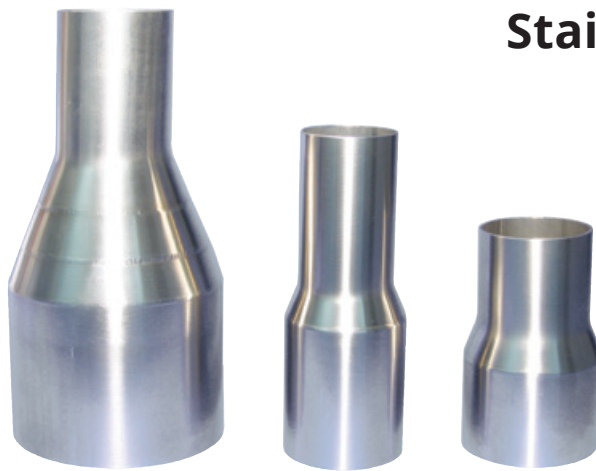

Stainless steel reducers

Material no. AISI 304 / 304 L

Stainless steel reducers				
D1 Diameter x wall	D2 Diameter x wall	Length L	Weight	Article number
114.3 x 2.0 mm	65.0 x 2.0 mm	300 mm	1.31 kg	81141RZ10
114.3 x 2.0 mm	80.0 x 2.0 mm	300 mm	1.42 kg	81141RZ31
114.3 x 2.0 mm	88.9 x 2.0 mm	200 mm	0.99 kg	81141RZ15
114.3 x 2.0 mm	88.9 x 2.0 mm	300 mm	1.48 kg	81141RZ26
114.3 x 2.0 mm	100.0 x 1.5 mm	300 mm	1.39 kg	81141RZ29
114.3 x 2.0 mm	101.6 x 2.0 mm	200 mm	1.05 kg	81141RZ14
114.3 x 2.0 mm	104.0 x 2.0 mm	300 mm	1.60 kg	81141RZ08
114.3 x 2.0 mm	108.0 x 2.0 mm	300 mm	1.63 kg	81141RZ30

129.0 x 2.0 mm	104.0 x 2.0 mm	300 mm	1.71 kg	81291RZ04
129.0 x 2.0 mm	114.3 x 2.0 mm	300 mm	1.78 kg	81291RZ03

154.0 x 2.0 mm	104.0 x 2.0 mm	300 mm	1.89 kg	81541RZ23
154.0 x 2.0 mm	104.0 x 2.0 mm	450 mm	2.84 kg	81541RZ12
154.0 x 2.0 mm	114.3 x 2.0 mm	450 mm	2.95 kg	81541RZ05
154.0 x 2.0 mm	129.0 x 2.0 mm	300 mm	2.08 kg	81541RZ04
154.0 x 2.0 mm	129.0 x 2.0 mm	450 mm	3.17 kg	81541RZ19
154.0 x 2.0 mm	139.7 x 2.0 mm	450 mm	3.24 kg	81541RZ07

Special models at request

Glass reducers

other dimensions available at request



Glass reducers			
D1 Diameter x wall	D2 Diameter x wall	Length L	Article number
66.0 x .0 mm	56 x 5.0 mm	200 mm	8066BRZ01

HVA NIRO® Stainless steel reducers



HVA NIRO® Stainless steel reducers				
D1 Diameter x wall	D2 Diameter x wall	Length L	Weight	Article number
40.0 x 1.5 mm	38.0 x 1.5 mm	150 mm	0.20 kg	80401RZ02-9
○ 45.0 x 1.5 mm	40.0 x 1.5 mm	120 mm	0.18 kg	80451RZ02-9
○ 45.0 x 1.5 mm	38.0 x 1.5 mm	110 mm	0.33 kg	80451RZ04-9
50.0 x 1.5 mm	45.0 x 1.5 mm	150 mm	0.24 kg	80501RZ20-9
○ 50.0 x 1.5 mm	45.0 x 1.5 mm	200 mm	0.34 kg	80501RZ12-9
○ 50.0 x 1.5 mm	40.0 x 1.5 mm	120 mm	0.16 kg	80501RZ01-9
50.0 x 1.5 mm	40.0 x 1.5 mm	150 mm	0.24 kg	80501RZ15-9
○ 50.0 x 1.5 mm	40.0 x 1.5 mm	200 mm	0.30 kg	80501RZ04-9
○ 50.0 x 1.5 mm	38.0 x 1.5 mm	150 mm	0.22 kg	80501RZ05-9
○ 60.3 x 2.0 mm	50.0 x 1.5 mm	150 mm	0.30 kg	80601RZ09-9
60.3 x 2.0 mm	50.0 x 1.5 mm	200 mm	0.45 kg	80601RZ04-9
○ 60.3 x 2.0 mm	45.0 x 1.5 mm	200 mm	0.44 kg	80601RZ06-9
○ 60.3 x 2.0 mm	40.0 x 1.5 mm	200 mm	0.37 kg	80601RZ10-9
○ 60.3 x 1.5 mm	50.0 x 1.5 mm	120 mm	0.22 kg	80601RZ21-9
60.3 x 1.5 mm	45.0 x 1.5 mm	125 mm	0.22 kg	80601RZ19-9
○ 60.3 x 1.5 mm	38.0 x 1.5 mm	128 mm	0.23 kg	80601RZ20-9
○ 65.0 x 2.0 mm	60.3 x 2.0 mm	200 mm	0.65 kg	80651RZ07-9
○ 65.0 x 2.0 mm	50.0 x 1.5 mm	200 mm	0.42 kg	80651RZ02-9

Special models at request

○ = no stock article | available at short notice

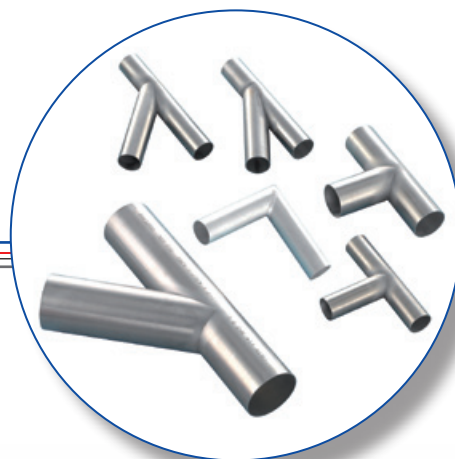
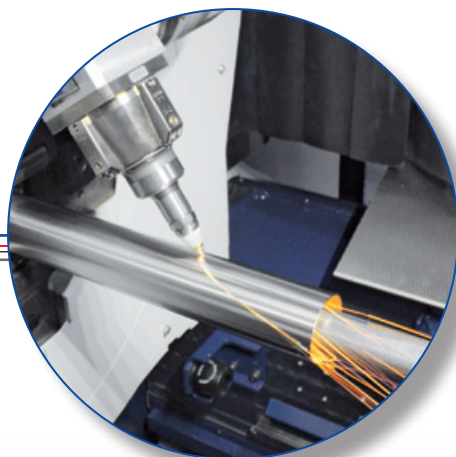

For pipes from diameter 38.0 mm to diameter 254.0 mm with diagonal cut



**see the video
on our website**

Suction lances

Aluminium AlMgSi 0,5 F22



Suction lances

- Aluminium casing made of AlMgSi 0.5 F22
Suction pipe: Material no. AISI 304
- We produce according to your drawing, sketch or sample
- Deliverable in different diameters
- Special models are available at short notice
- In common pipe diameters 40.0 / 50.0 and 60.3 mm from stock



Aluminium suction lances with spacer

Type	Connection Ø	Wall thickness	Length	Weight	Article number
ALU	40.0 mm	1.5 mm	1000.0 mm	1.70 kg	SAUGR040A
ALU	50.0 mm	1.5 mm	1000.0 mm	1.94 kg	SAUGR050A
ALU	60.0 mm	2.0 mm	1000.0 mm	2.48 kg	SAUGR060A

Suction lances

Stainless steel AISI 304

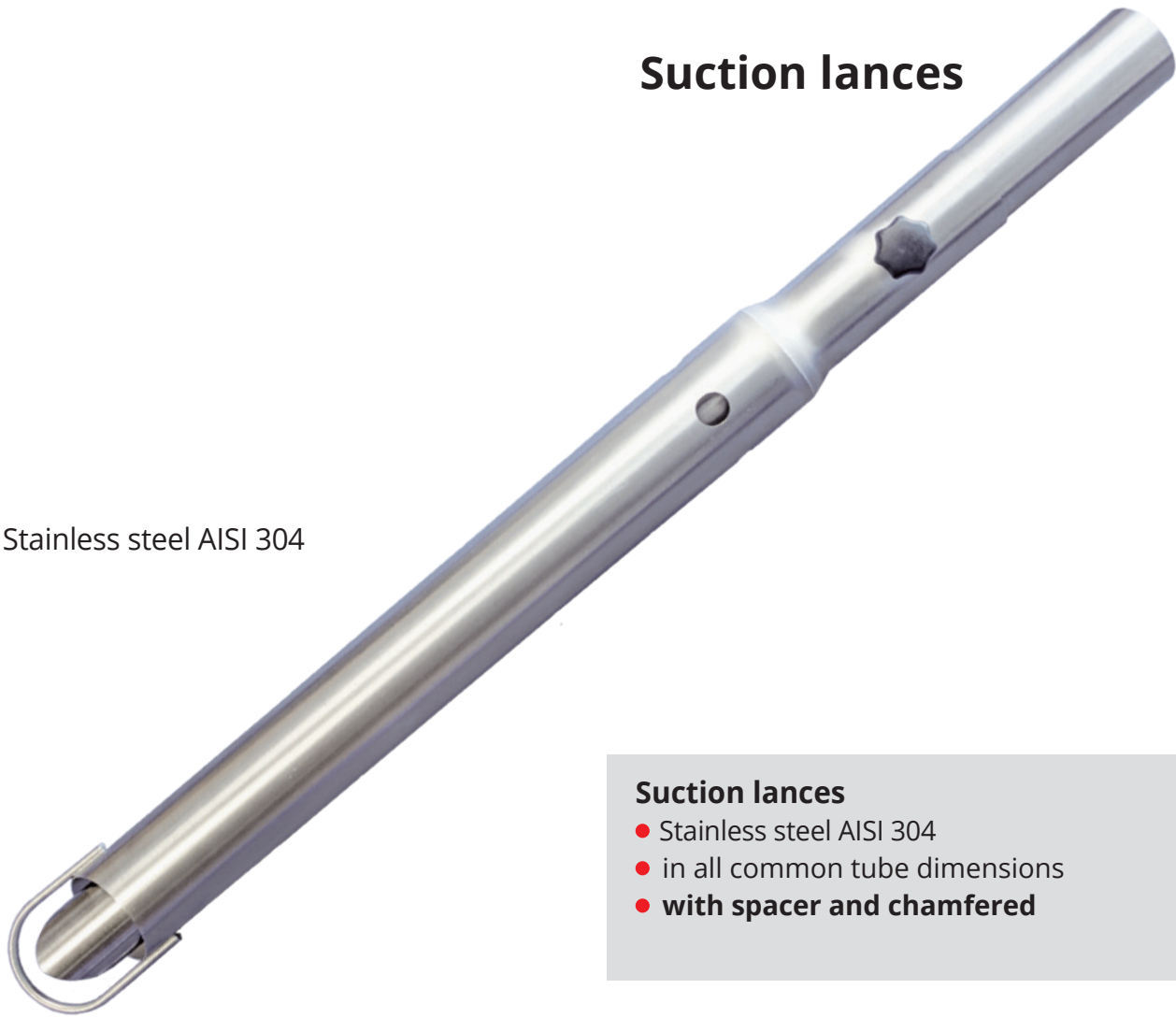

Suction lances

- Stainless steel AISI 304
- in all common tube dimensions
- **with spacer and chamfered**

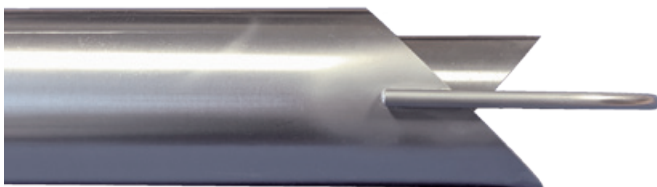

Stainless steel suction lances with spacer and chamfered

Type	Connection Ø	Wall thickness	Length	Weight	Article number
Spacer and chamfered	38.0 mm	1.5 mm	1000.0 mm	3.22 kg	SAUGR0383-G
Spacer and chamfered	40.0 mm	1.5 mm	1000.0 mm	3.56 kg	SAUGR0403-G
Spacer and chamfered	45.0 mm	1.5 mm	1000.0 mm	3.90 kg	SAUGR0453-G
Spacer and chamfered	50.0 mm	1.5 mm	1000.0 mm	3.92 kg	SAUGR0503-G
Spacer and chamfered	54.0 mm	2.0 mm	1000.0 mm	4.52 kg	SAUGR0543-G
Spacer and chamfered	60.3 mm	1.5 mm	1000.0 mm	4.94 kg	SAUGR0603-G
Spacer and chamfered	65.0 mm	2.0 mm	1000.0 mm	5.96 kg	SAUGR0653-G
Spacer and chamfered	70.0 mm	2.0 mm	1000.0 mm	6.80 kg	SAUGR0703-G
Spacer and chamfered	76.0 mm	2.0 mm	1000.0 mm	7.70 kg	SAUGR0763-G

Suction lances

Stainless steel AISI 304

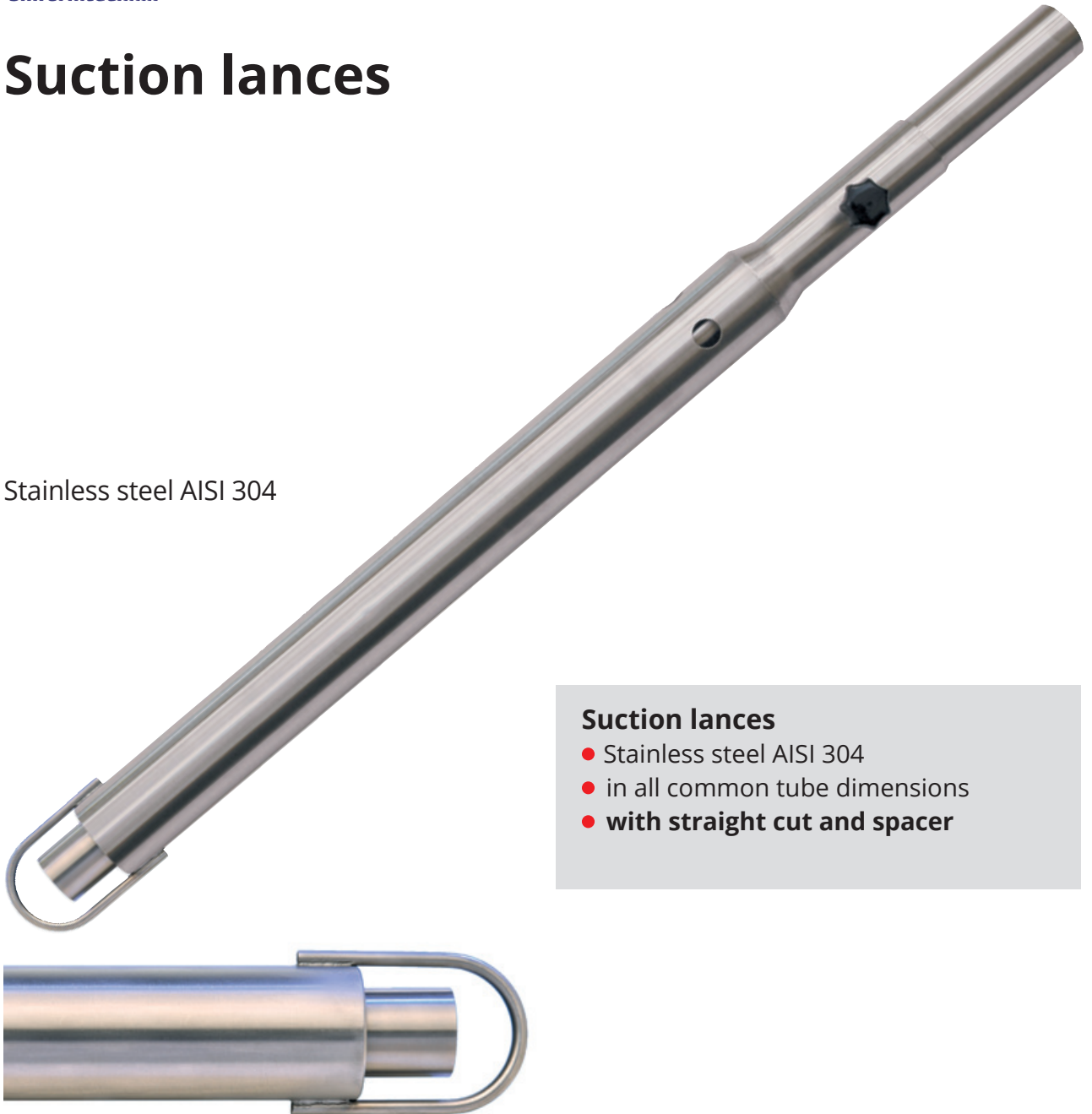

Suction lances

- Stainless steel AISI 304
- in all common tube dimensions
- **with straight cut and spacer**

Stainless steel suction lances with spacer

Type	Connection Ø	Wall thickness	2. Dia-meter	2. Wall thickness	Length	Weight	Article number
Spacer	38.0 mm	1.5 mm	60.3 mm	2.0 mm	1000.0 mm	5.00 kg	SAUGR0381
Spacer	40.0 mm	1.5 mm	65.0 mm	2.0 mm	1000.0 mm	3.70 kg	SAUGR0401
Spacer	45.0 mm	1.5 mm	70.0 mm	2.0 mm	1000.0 mm	4.10 kg	SAUGR0451
Spacer	50.0 mm	1.5 mm	70.0 mm	2.0 mm	1000.0 mm	4.40 kg	SAUGR0501
Spacer	54.0 mm	2.0 mm	76.1 mm	2.0 mm	1000.0 mm	5.44 kg	SAUGR0541
Spacer	60.3 mm	2.0 mm	80.0 mm	1.5 mm	1000.0 mm	5.24 kg	SAUGR0601
Spacer	65.0 mm	2.0 mm	88.9 mm	2.0 mm	1000.0 mm	6.62 kg	SAUGR0651
Spacer	70.0 mm	2.0 mm	101.6 mm	2.0 mm	1000.0 mm	7.02 kg	SAUGR0701
Spacer	76.1 mm	2.0 mm	101.6 mm	2.0 mm	1000.0 mm	7.26 kg	SAUGR0761

Suction lances

Stainless steel AISI 304



Suction lances

- Stainless steel AISI 304
- in all common tube dimensions
- **with chamfered**

Stainless steel suction lances with chamfered

Type	Connection Ø	Wall thickness	2. Dia-meter	2. Wall thickness	Length	Weight	Article number
Chamfered	38.0 mm	1.5 mm	60.3 mm	2.0 mm	1000.0 mm	3.22 kg	SAUGR0381-G
Chamfered	40.0 mm	1.5 mm	65.0 mm	2.0 mm	1000.0 mm	3.56 kg	SAUGR0401-G
Chamfered	45.0 mm	1.5 mm	70.0 mm	2.0 mm	1000.0 mm	3.90 kg	SAUGR0451-G
Chamfered	50.0 mm	1.5 mm	70.0 mm	2.0 mm	1000.0 mm	3.92 kg	SAUGR0501-G
Chamfered	54.0 mm	2.0 mm	76.1 mm	2.0 mm	1000.0 mm	4.52 kg	SAUGR0541-G
Chamfered	60.3 mm	2.0 mm	80.0 mm	1.5 mm	1000.0 mm	4.94 kg	SAUGR0601-G
Chamfered	65.0 mm	2.0 mm	88.9 mm	2.0 mm	1000.0 mm	5.96 kg	SAUGR0651-G
Chamfered	70.0 mm	2.0 mm	101.6 mm	2.0 mm	1000.0 mm	6.80 kg	SAUGR0701-G
Chamfered	76.1 mm	2.0 mm	101.6 mm	2.0 mm	1000.0 mm	7.06 kg	SAUGR0761-G

Coupling stations / material distributors

manufactured to your individual specifications



We can deliver coupling stations / material distributors – **at short notice**, manufactured to your individual specifications.

Coupling stations

- Units are mounted in a frame with outlets made of stainless steel tubes (e.g. 50.0 x 1.5 mm)
- Single units (bends, branch pipes, pipes) connected with DVK 6 vacuum couplings, exactly aligned and bolted to the frame construction using pipe clamps.
- Camlock connections made of aluminium at the upper outlets
- Base frame made of 40 x 40 x 2.0 mm stainless steel square pipes with transverse struts made of stainless steel, polished grain size 240

Coupling stations / material distributors

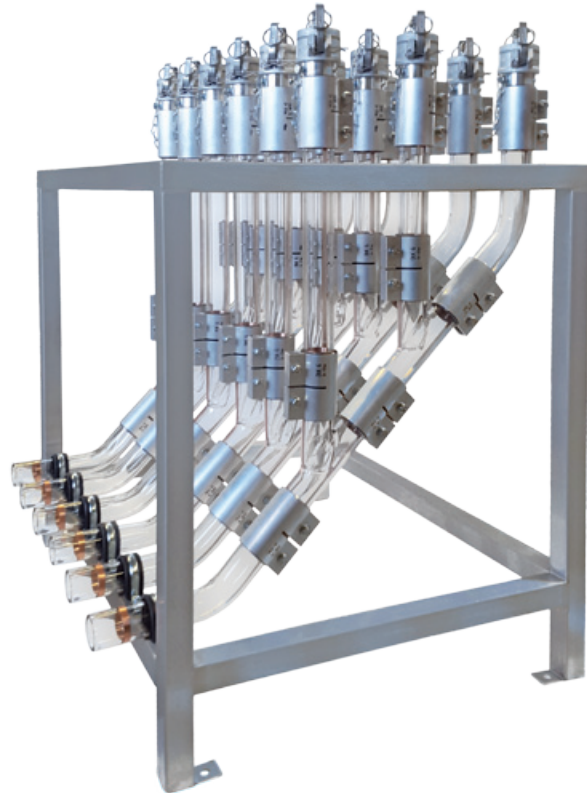
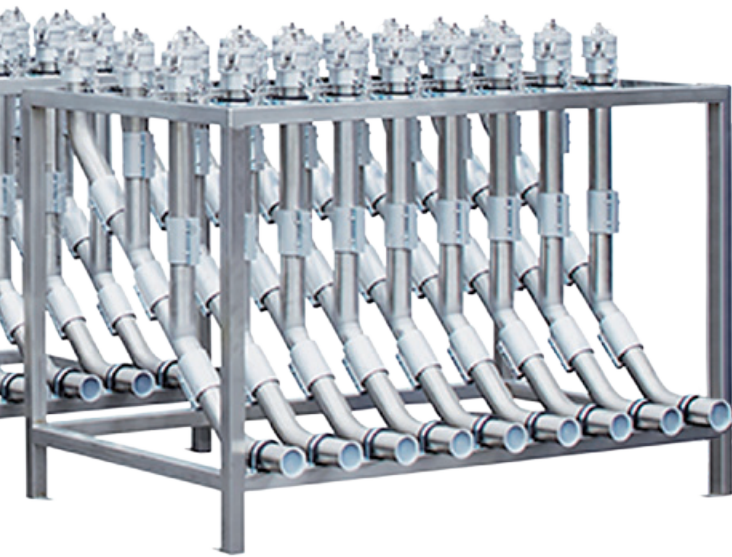

CAD drawings will be designed for your approval.

Example: **Glass coupling station**

Highly wear-resistant Coupling stations

We can offer single elements like bends, branches or tubes of **HVA NIRO®** (= **highly wear-resistant version**) or 3.3 borosilicate glass.



The design of our coupling stations

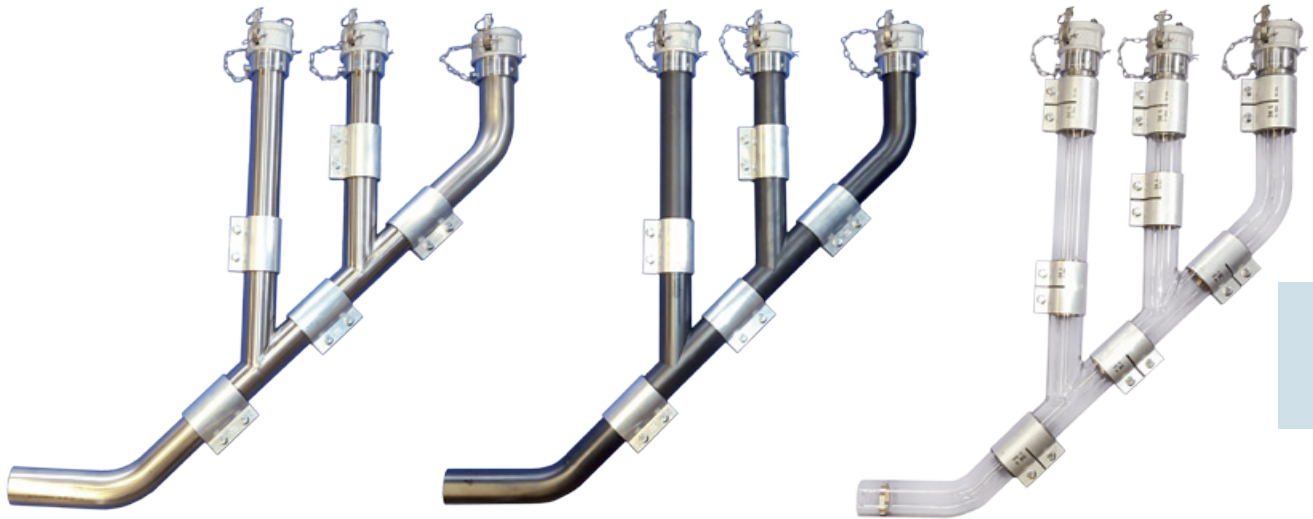

Standard element
stainless steel

HVA NIRO®

Glass

New

Example: inlet pipes in different levels

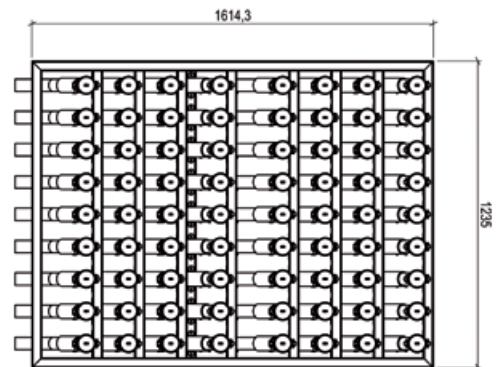
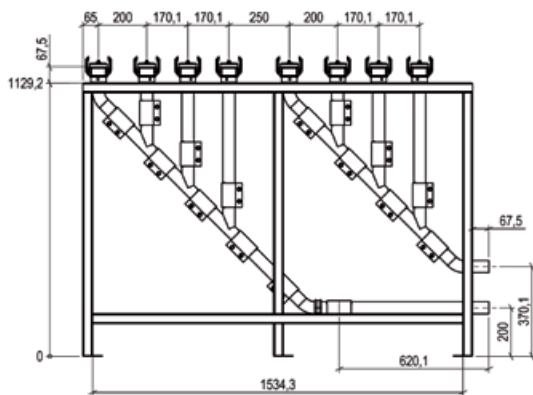

Example: special arrangement of the connections

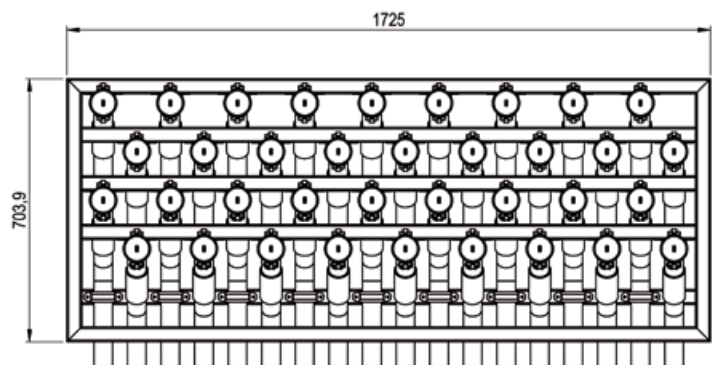
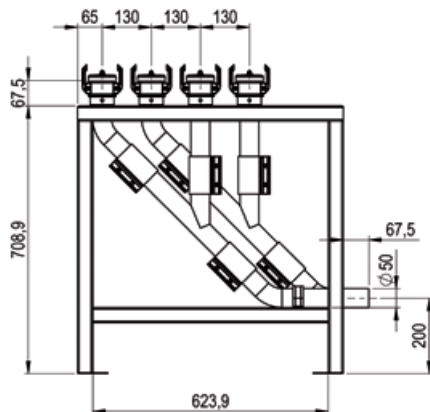

Standard design of a coupling station element

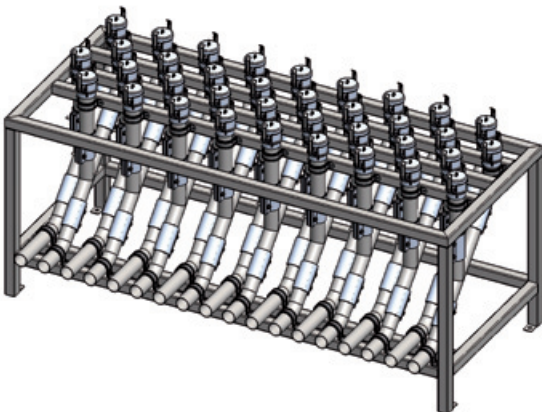
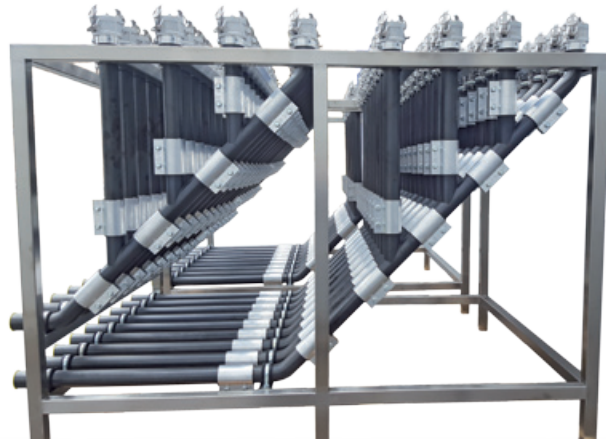
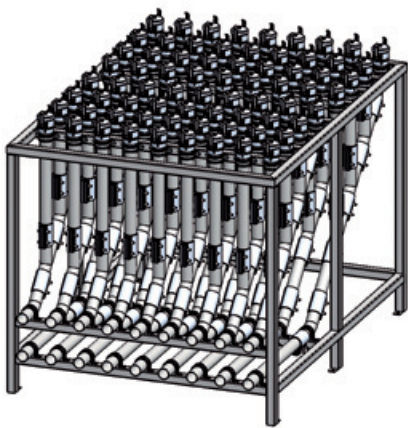
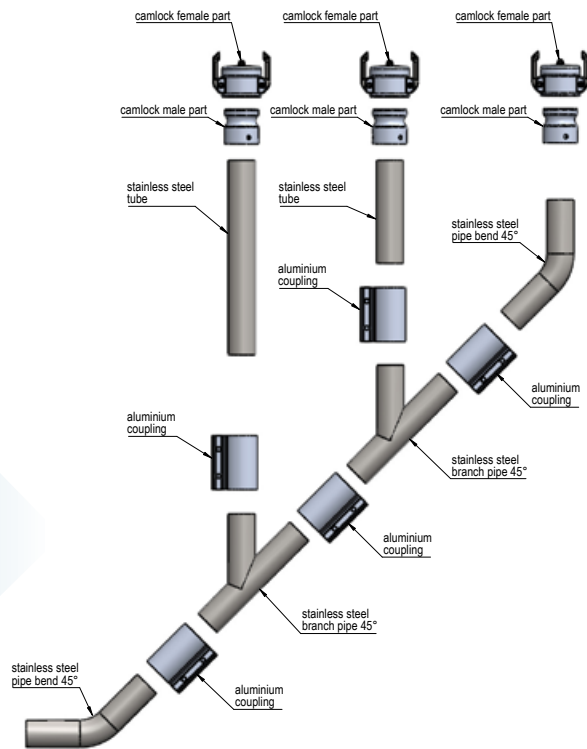

You can find other variants of coupling stations on Pages 100 and 101

More variants of our coupling stations

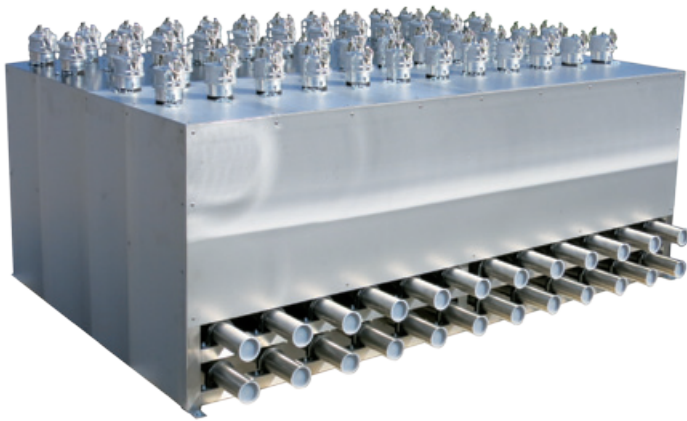

With cover panels | Stainless steel or aluminium



According to customer requirements

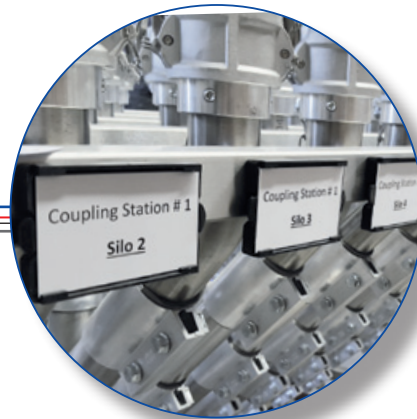

Special design according to customer requirements

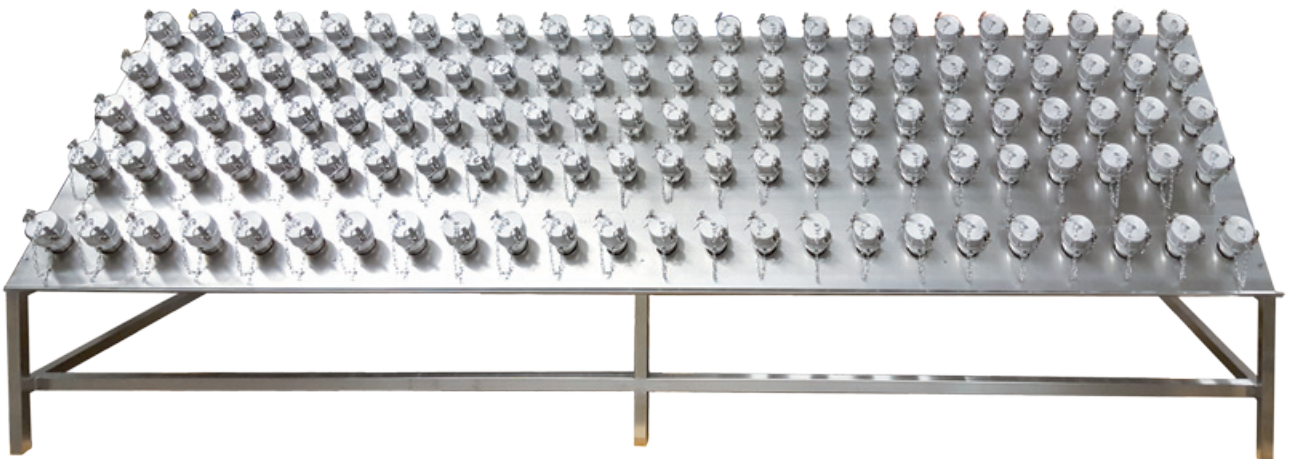

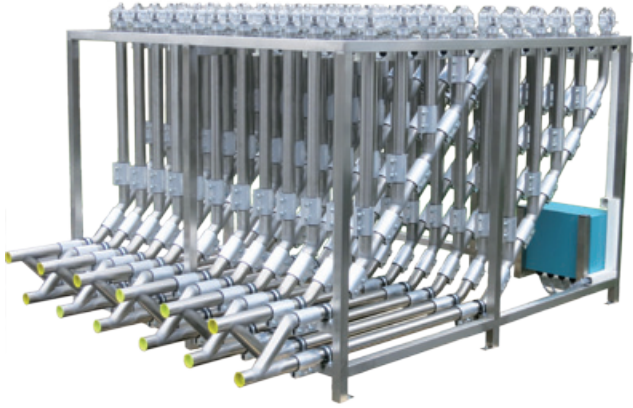

2 levels combined

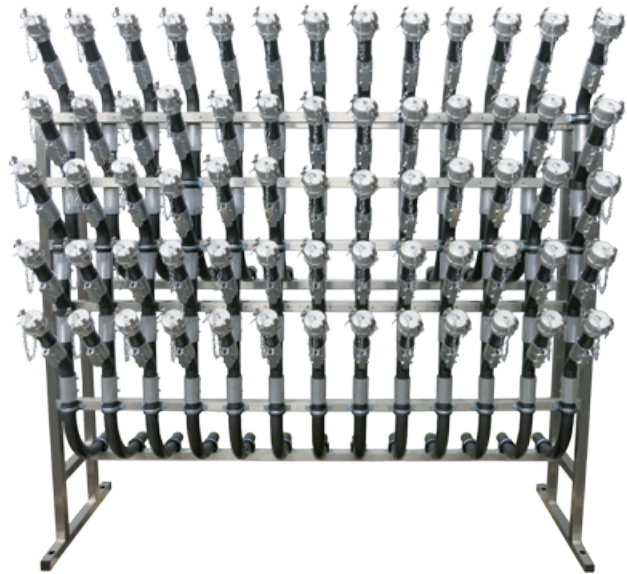

Vertical coupling station

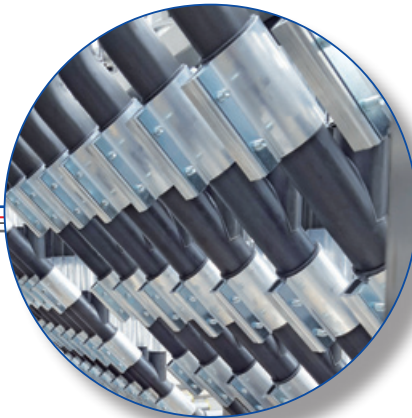

HVA NIRO®

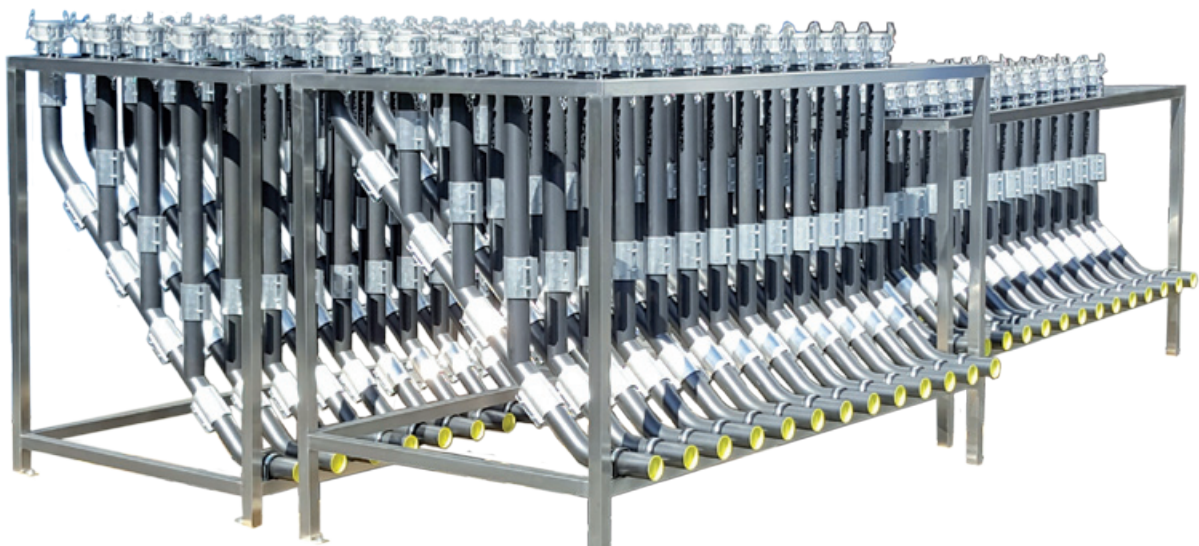

Special parts | Drawing parts

at request

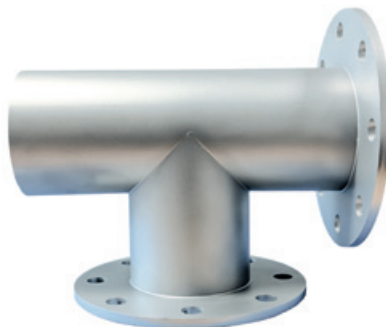
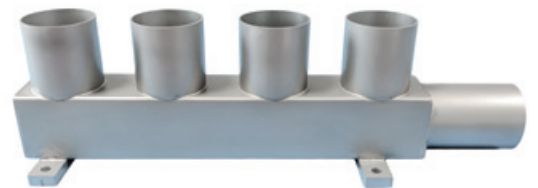
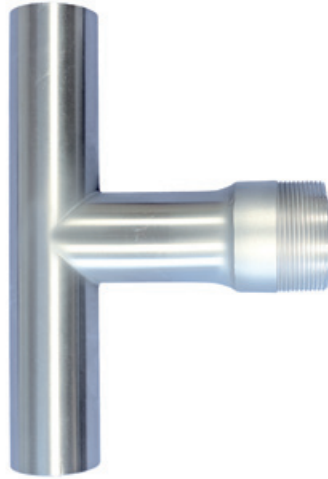

Special parts | Drawing parts



You can download blank drawings for special articles from our website: www.hs-umformtechnik.de

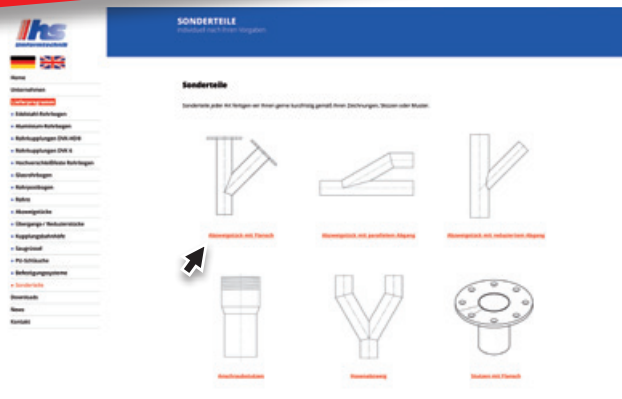

PU-Hoses



... matching hose clamps you can find under accessories - on page 109

Material

- Spiral: spring steel wire
- Wall: pure polyester polyurethane acc. DIN ISO 4649 more abrasion resistant in comparison to polyether polyurethane
- Wall thickness between spirals approx. 1.4 mm

Temperature range

- -40° C to +90° C; peaks to +125° C

Applications

- Suction of coarse-grained media with high flow rate
- For abrasive solids, gaseous, and liquid media
- Standard hose for industrial vacuum cleaners
- Granulate transport hose
- Transport of chips / shavings
- Suction and transport of paper fibres
- Oil mist extraction/suction

Master-PUR H Trivolution

The Master-PUR H Trivolution is a PU suction- and transport hose with good flexibility, permanently antistatic, microbe resistant and hardly inflammable according to DIN 4102 B1. The surface resistance is $< 10^9$ Ohm.

Properties

- hardly inflammable acc. to DIN 4102 B1
- permanently antistatic, surface resistance $RO < 10^9$ Ohm according to DIN EN ISO 8031:2010-04
- acco. to TRGS 727 (Zone 20) for combustible dusts/bulk solids for discharging electrostatic charges with grounding of the spiral ends on both sides
- mikrobe resistant
- good resistance to chemicals, oil and fuel
- small bending radius
- optimum flow characteristics
- highly abrasion-resistant
- medium duty - good flexibility
- free of halogens and plasticizers
- gas-tight
- increased pressure & vacuum resistance
- high tensile strength
- generally good UV and ozone resistance

PU-Hoses

Master-PUR H Trivolution						
Diameter	Length	Weight/m	Outer diameter approx.	Designation	Material	Article number
32 mm	at request	0.39 kg	41 mm	PUR-H	PU hose	7032MAPU1
38 mm	10 mtr.	0.46 kg	47 mm	PUR-H	PU hose	7038MAPU1-1
38 mm	15 mtr.	0.46 kg	47 mm	PUR-H	PU hose	7038MAPU1
38 mm	20 mtr.	0.46 kg	47 mm	PUR-H	PU hose	7038MAPU1-2
40 mm	10 mtr.	0.49 kg	49 mm	PUR-H	PU hose	7040MAPU1-1
40 mm	15 mtr.	0.49 kg	49 mm	PUR-H	PU hose	7040MAPU1
40 mm	20 mtr.	0.49 kg	49 mm	PUR-H	PU hose	7040MAPU1-2
45 mm	10 mtr.	0.55 kg	55 mm	PUR-H	PU hose	7045MAPU1-1
45 mm	15 mtr.	0.55 kg	55 mm	PUR-H	PU hose	7045MAPU1
45 mm	20 mtr.	0.55 kg	55 mm	PUR-H	PU hose	7045MAPU1-2
50 mm	10 mtr.	0.71 kg	61 mm	PUR-H	PU hose	7050MAPU1-1
50 mm	15 mtr.	0.71 kg	61 mm	PUR-H	PU hose	7050MAPU1
50 mm	20 mtr.	0.71 kg	61 mm	PUR-H	PU hose	7050MAPU1-2
60 mm	10 mtr.	0.84 kg	70 mm	PUR-H	PU hose	7060MAPU1-1
60 mm	15 mtr.	0.84 kg	70 mm	PUR-H	PU hose	7060MAPU1
60 mm	20 mtr.	0.84 kg	70 mm	PUR-H	PU hose	7060MAPU1-2
63 mm	at request	0.88 kg	72,6 mm	PUR-H	PU hose	7063MAPU1
65 mm	at request	0.91 kg	75 mm	PUR-H	PU hose	7065MAPU1
70 mm	at request	0.97 kg	80 mm	PUR-H	PU hose	7070MAPU1
75 mm	at request	1.06 kg	87 mm	PUR-H	PU hose	7075MAPU1
80 mm	at request	1.11 kg	91 mm	PUR-H	PU hose	7080MAPU1
90 mm	at request	1.25 kg	101 mm	PUR-H	PU hose	7090MAPU1
100 mm	at request	1.48 kg	112 mm	PUR-H	PU hose	7100MAPU1
110 mm	at request	1.61 kg	121 mm	PUR-H	PU hose	7110MAPU1
120 mm	at request	1.75 kg	131 mm	PUR-H	PU hose	7120MAPU1

PU-Hoses



... matching hose clamps you can find under accessories - on page 109

Master-PUR HX Trivolution

The Master-PUR HX Trivolution is a highly abrasion resistant and vacuum proof PU suction hose and transport hose with reinforcement underneath the spiral. It is permanently antistatic, microbe-resistant, hardly inflammable (acc. to DIN 4102 B1) with a surface resistance $< 10^9$ Ohm.

Material

- Spiral: spring steel wire
- Wall: pure polyester polyurethane acc. DIN ISO 4649 more abrasion-resistant in comparison to polyether polyurethane
- Wall thickness between the spirals approx. 1.7 - 2.1 mm, depending on DN

Temperature range

- -40°C to $+90^{\circ}\text{C}$; peaks to $+125^{\circ}\text{C}$

Applications

- for increased requirements of abrasion resistance and durability
- Suction & transport hose for extremel abrasive media
- Flat-roof gravelling
- Workinghose for silo vehicles and cargo depots
- Transport hose for problematic media, e.g. sand, gravel, grain, granules

Properties

- hardly inflammable acc. to DIN 4102 B1
- permanently antistatic, surface-resistance $RO < 10^9$ Ohm, acc. to DIN EN ISO 8031:2010-04
- approved acco. to TRGS 727 (Zone 20) and ATEX 2014/34 EU
- microbe-resistant
- extremely abrasion resistant via specific reinforcements underneath the spiral
- resistant to oil and fuel
- flexible
- halogen and plasticizer-free
- smooth inner lining, optimum flow characteristics
- high vacuum and apex pressure resistance
- high durable long service lifes
- good resistance to chemicals
- generally good UV and ozone resistance

PU-Hoses

Master-PUR HX Trivolution						
Diameter	Length	Weight/m	Outer diameter approx.	Designation	Material	Article number
32 mm	at request	0.66 kg	42 mm	PUR-HX	PU hose	7032MAPU2
38 mm	at request	0.78 kg	48 mm	PUR-HX	PU hose	7038MAPU2
40 mm	at request	0.83 kg	50 mm	PUR-HX	PU hose	7040MAPU2
45 mm	at request	0.92 kg	55 mm	PUR-HX	PU hose	7045MAPU2
50 mm	at request	1.04 kg	60 mm	PUR-HX	PU hose	7050MAPU2
60 mm	at request	1.20 kg	70 mm	PUR-HX	PU hose	7060MAPU2
65 mm	at request	1.29 kg	75 mm	PUR-HX	PU hose	7065MAPU2
70 mm	at request	1.38 kg	80 mm	PUR-HX	PU hose	7070MAPU2
75 mm	at request	1.50 kg	85 mm	PUR-HX	PU hose	7075MAPU2
75 mm	at request	1.50 kg	85 mm	PUR-HX	PU hose	7076MAPU2
80 mm	at request	1.93 kg	93 mm	PUR-HX	PU hose	7080MAPU2
90 mm	at request	2.16 kg	103 mm	PUR-HX	PU hose	7090MAPU2
100 mm	at request	2.60 kg	113 mm	PUR-HX	PU hose	7100MAPU2
110 mm	at request	2.82 kg	124 mm	PUR-HX	PU hose	7110MAPU2
120 mm	at request	3.07 kg	134 mm	PUR-HX	PU hose	7120MAPU2
125 mm	at request	3.44 kg	138 mm	PUR-HX	PU hose	7125MAPU2

PVC-Hoses

NORPLAST® PVC-CU 384 AS

... matching hose clamps you can find under accessories - on page 109

The NORPLAST® PVC-CU 384 AS is a suction and transport hose with following properties: heavy duty, smooth interior, with grounding wire, permanently antistatic wall; electrical and surface resistance 10^9 Ohm approx.

NORPLAST® PVC-CU 384 AS						
Diameter	Length	Weight/m	Outer diameter approx.	Designation	Material	Article number
40 mm	at request	0.57 kg	48 mm	N 384 C-AS	PVC hose	7040NOPV3
50 mm	at request	0.82 kg	59 mm	N 384 C-AS	PVC hose	7050NOPV3
60 mm	at request	0.99 kg	69 mm	N 384 C-AS	PVC hose	7060NOPV3

Accessories | Gaskets

**Factory certificate -
at request**

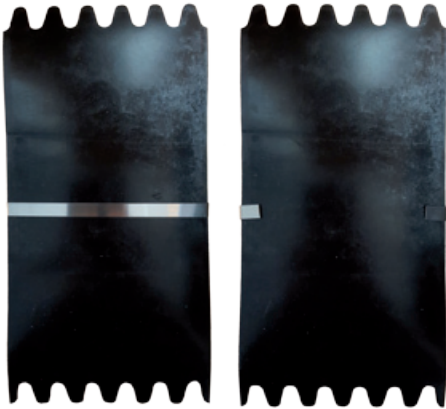

Natural black rubber	
Hardness in shore	65 +/- 5
Temperature resistance in °C	-20 °C to + 60 °C
Tensile strength in Mpa	3
Elongation at break in %	180
FDA conform	NO
with reinforcement inlay	NO



EPDM white	
Hardness in shore	60 +/- 5
Temperature resistance in °C	-20°C to + 120°C
Tensile strength in Mpa	5
Elongation at break in %	350
FDA conform	YES
with reinforcement inlay	YES

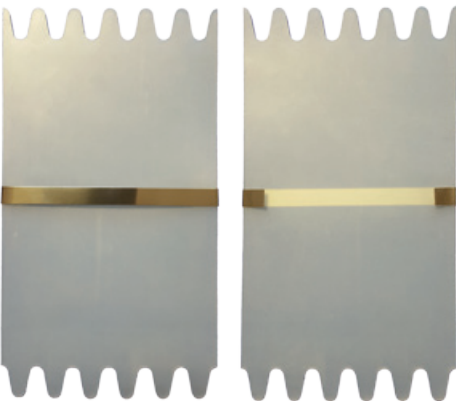

Nitrile white	
Hardness in shore	70 +/- 5
Temperature resistance in °C	-20°C to + 80°C
Tensile strength in Mpa	5
Elongation at break in %	250
FDA conform	YES
with reinforcement inlay	YES

Silikone transparent	
Hardness in shore	60 +/- 5
Temperature resistance in °C	-20°C to + 200°C
Tensile strength in Mpa	9
Elongation at break in %	300
FDA conform	NO
with reinforcement inlay	YES

**further materials (see page 60)
available at request**

Accessories | Hose clamps

Hose clamps with bolts		
Diameter	Designation	Article number
40-43 mm	Hose clamp	7032MARBS
44-47 mm	Hose clamp	7038MARBS
48-51 mm	Hose clamp	7040MARBS
52-55 mm	Hose clamp	7045MARBS
56-59 mm	Hose clamp	7050MARBS
64-67 mm	Hose clamp	7055MARBS
68-73 mm	Hose clamp	7060MARBS
74-79 mm	Hose clamp	7065MARBS
80-85 mm	Hose clamp	7070MARBS
86-91 mm	Hose clamp	7075MARBS
86-91 mm	Hose clamp	7080MARBS
98-103 mm	Hose clamp	7090MARBS
104-112 mm	Hose clamp	7100MARBS
113-121 mm	Hose clamp	7110MARBS
122-130 mm	Hose clamp	7115MARBS



Hose clamps DIN 3017 with screw thread		
Diameter	Designation	Article number
40-60 mm	hose clamp with screw thread	7040HCS12
60-80 mm	hose clamp with screw thread	7060HCS12



Accessories | Camlock-couplings

Material: Aluminium



Camlock couplings are available in different dimensions for coupling stations. They are suitable for tube diameters 40.0 / 50.0 / 60.3 and 65.0 mm and have the following characteristics:

- Male parts of aluminium
- Covering caps in aluminium
- Female part with hose connector in aluminium or stainless steel

Male part mounted directly onto pipe (no material contact)



Diameter	Type labeling	Article number
40 mm / 1 1/2"		KK0405VT1
45 mm / 2"		KK0455VT1
50 mm / 2"		KK0505VT1
60 mm / 2 1/2"		KK0605VT1
76,1 mm / 3"		KK0765VT1

Female part as covering cap



Diameter	Type labeling	Article number
40 mm	DC-150	KK0405MK1
50 mm (suitable to male part Ø 45 mm)	DC-200	KK0505MK1
60 / 65 mm	DC-250	KK0655MK1
75 mm	DC-300	KK0755MK1
100 mm	DC-400	KK1005MK1



Chains for Camlock- / Storz couplings, material: galvanized steel

Diameter	Type labeling	Article number
ca. 27 cm (6 links)		KETTEN001

Camlock couplings

Material: Aluminium

Female part as hose connector

Diameter	Type labeling	Article number
40 mm	C-150	KK0405MS1
50 mm	C-200	KK0505MS1
60 mm		KK0605MS1
65 mm	C-250	KK0655MS1
75 mm	C-300	KK0755MS1
100 mm	C-400	KK1005MS1



Female part with built-in piece of stainless steel pipe, material contacted parts made of ss

Diameter	Type labeling	Article number
40 mm / 38 mm		KK0385MR2
40 mm		KK0405MR2
50 mm / 45 mm		KK0455MR2
50 mm		KK0505MR2
50 mm / 54 mm		KK0545MR2
60 mm		KK0605MR2
60 mm / 65 mm		KK0655MR2



Female part for mounting onto pipe

Diameter	Type labeling	Article number
40 mm		KK0405MR1
50 mm		KK0505MR1
60 mm		KK0605MR1



Male part blind cap

Diameter	Type labeling	Article number
40 mm / 1 1/2"	DP-150	KK0405ST1
50 mm / 2"	DP-200	KK0505ST1
60 / 65 mm / 2 1/2"	DP-250	KK0655ST1
75 mm / 3"	DP-300	KK0755ST1
100 mm / 4"	DP-400	KK1005ST1



Camlock couplings

Material: Aluminium



Male part with hose connector

Diameter	Type labeling	Article number
40 mm	E-150	KK0405VS1
50 mm	E-200	KK0505VS1
65 mm	E-250	KK0655VS1
75 mm	E-300	KK0755VS1
100 mm	E-400	KK1005VS1

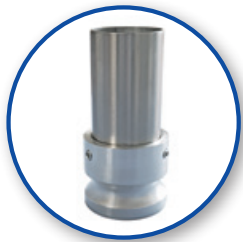

Male part with built-in piece of stainless steel pipe, material contacted components made of ss

Diameter	Type labeling	Article number
40 mm / 38 mm		KK0385VS2
40 mm		KK0405VS2
50 mm / 45 mm		KK0455VS2
50 mm		KK0505VS2
50 mm / 54 mm		KK0545VS2
60 mm		KK0605VS2
60 mm / 65 mm		KK0655VS2
76,1 mm		KK0765VS2
76,1 mm / 70 mm		KK0705VS2



Male part with inner thread

Diameter	Type labeling	Article number
40 mm / 1 1/2"	A-150	KK0405VT2
50 mm / 2"	A-200	KK0505VT2
65 mm / 2 1/2"	A-250	KK0655VT1
75 mm / 3"	A-300	KK0755VT1
100 mm / 4"	A-400	KK1005VT1



Female part with inner thread

Diameter	Type labeling	Article number
40 mm / 1 1/2"	D-150	KK0405MG1
50 mm / 2"	D-200	KK0505MG1
65 mm / 2 1/2"	D-250	KK0655MG1
75 mm / 3"	D-300	KK0755MG1
100 mm / 4"	D-400	KK1005MG1

Camlock couplings

Material: Stainless steel

at request

Male part with inner thread - stainless steel

Diameter	Type labeling	Article number
40 mm / 1 1/2"	A-150 „VA“	KK0401VT1
50 mm / 2"	A-200 „VA“	KK0501VT1
65 mm / 2 1/2"	A-250 „VA“	KK0651VT1
75 mm / 3"	A-300 „VA“	KK0751VT1
100 mm / 4"	A-400 „VA“	KK1001VT1



Male part with hose connector - stainless steel

Diameter	Type labeling	Article number
40 mm	E-150 „VA“	KK0401VS1
50 mm	E-200 „VA“	KK0501VS1
65 mm	E-250 „VA“	KK0651VS1
75 mm	E-300 „VA“	KK0751VS1
100 mm	E-400 „VA“	KK1001VS1



Female part with hose connector - stainless steel

Diameter	Type labeling	Article number
40 mm	C-150 „VA“	KK0401MS1
50 mm	C-200 „VA“	KK0501MS1
65 mm	C-250 „VA“	KK0651MS1
75 mm	C-300 „VA“	KK0751MS1
100 mm	C-400 „VA“	KK1001MS1



Accessories | Storz couplings

Material: Aluminium | Stainless steel



Storz couplings are available in all common sizes (A, B, C) in stainless steel or aluminium in following versions:

- Solid coupling
 - with inner thread
 - with outer thread
- Cap fire hose coupling
- Suction coupling



Type: fixed coupling C-52, KA 66

Diameter	Article number
Inner thread 1,5"	ST0525FK2
Inner thread 2,0"	ST0525FK1
Inner thread 2,5"	ST0525FK3



Type: cap fire hose coupling C-52, KA 66

Diameter	Article number
Blind cap	ST0525BK1



Type: suction coupling C-52, KA 66

Diameter	Article number
38 mm hose connection	ST0525SK3
40 mm hose connection	ST0525SK5
45 mm hose connection	ST0525SK6
50 mm hose connection	ST0525SK4
52 mm hose connection	ST0525SK2
60 mm hose connection	ST0525SK1
65 mm hose connection	ST0525SK7

Storz couplings

Material: Aluminium | Stainless steel

Type: Fixed coupling B-75, KA 89

Diameter	Article number
Inner thread 2,0"	ST0755FK2
Inner thread 2,5"	ST0755FK1
Inner thread 3,0"	ST0755FK3



Type: cap fire hose coupling B-75, KA 89

Diameter	Article number
Blind cap	ST0755BK1



Type: suction coupling B-75, KA 89

Diameter	Article number
52 mm hose connection	ST0755SK1
60 mm hose connection	ST0755SK2
65 mm hose connection	ST0755SK5
70 mm hose connection	ST0755SK6
75 mm hose connection	ST0755SK4
80 mm hose connection	ST0755SK3



Type: fixed coupling A-110, KA 133

Diameter	Article number
Inner thread 3,0"	ST1105FK2
Inner thread 4,0"	ST1105FK1



Type: cap fire hose coupling A-110, KA 133

Diameter	Article number
Blind cap	ST1105BK1



Type: suction coupling A-110, KA 133

Diameter	Article number
90 mm hose connection	ST1105SK2
100 mm hose connection	ST1105SK1
110 mm hose connection	ST1105SK3
125 mm hose connection	ST1105SK4



Pinch valve switch DN 40 - 80 mm

parallel – HVA NIRO®

The 2-way switch – as a pinch valve switch – is used just before a product separator which is installed on an extruder or an injection moulding machine.

It is installed directly in the product line. It can be installed in any position.

This 2-way switch is a unit that can be controlled with 5/2 ways. It serves to control 2 products (new materials and recycled materials) in the proportion of, for example, 80 % to 20 %.

The switch ensures an absolutely leak-proof system in the product line when the pinch valve opens to switch over to the recycled product. Particles enclosed in the pinch hose do not impair the leak-proof capability.

It is important to note that the system pressure should not exceed a maximum of 2.5 bar. Greater pressure could damage the valves. In the event of a partial vacuum in the pipeline, it is important to ensure that pressure compensation is created in the system.



- The pinch valve is a 2/2-way valve for controlling material flows.
- In neutral position, it is open.
- The shut-off element is a tubular pinch element made of elastomer (natural rubber, Viton, EPDM etc.) very hard-wearing.
- When the control air is removed, the tubular pinch element opens, and the product stream is released.
- The valve is designed as an opener, and opens through residual stress after removal of the pressure.
- The valve also allows liquid and gaseous media to be shut off. The free passage when the valve is open provides for minimum flow resistance and prevents clogging or choking.

Empty suction switch DN 40 - 80 mm

The suction extraction switch is used directly at the silo, extraction funnel or container.

It is installed directly in the product line. It can be installed in any position.

This suction extraction switch is a unit that can be controlled with 5/2 ways. It serves to extract all residues from the product line by means of suction after every conveying cycle

The switch ensures an absolutely leak-proof system in the product line when the valve opens for extraction.

Particles enclosed in the pinch hose do not impair the leak-proof capability.

When the pinch valve opens on the atmospheric side, air flows through an inlet strainer (as a protective device) into the conveying line and extracts the granulate particles.

It is important to note that the system pressure should not exceed a maximum of 2.5 bar. Greater pressure could damage the valves. In the event of a partial vacuum in the pipeline, it is important to ensure that pressure compensation is created in the system.







Please also visit our website:
www.hs-umformtechnik.de



HS Umformtechnik GmbH
Gewerbestraße 1
D-97947 Grünsfeld-Paimar

Telephone +49 (0) 93 46 / 92 99-0

Telefax +49 (0) 93 46 / 92 99-200

kontakt@hs-umformtechnik.de

www.hs-umformtechnik.de

